



**PRELIMINARY
OPERATING AND PROGRAMMING MANUAL**

**1980 A/B
OSCILLOSCOPE MEASUREMENT SYSTEM**

SERIAL NUMBERS

This Manual applies directly to instruments with serial numbers prefixed **1947A**. For additional information about serial numbers, refer to **INSTRUMENTS COVERED BY MANUAL**, in Section I.

P. AUSTGEN
M. HARMS
J. HARTZLER
D. JOHNSON
J. SCHEETZ
J. VIVEIROS

© COPYRIGHT HEWLETT-PACKARD COMPANY/COLORADO SPRINGS DIVISION 1980
1900 GARDEN OF THE GODS ROAD, COLORADO SPRINGS, COLORADO, U.S.A.

ALL RIGHTS RESERVED

OPERATING AND PROGRAMMING MANUAL PART NO. 01980-90902
Operating and Programming Microfiche Part No. 01980-90802
Operating and Service Manual Part No. 01980-90901
Operating and Service Microfiche Part No. 01980-90801

PRINTED JULY 1980

SAFETY CONSIDERATIONS

GENERAL — This is a Safety Class I instrument (provided with terminal for protective earthing).

OPERATION — BEFORE APPLYING POWER verify that the power transformer primary is matched to the available line voltage, the correct fuse is installed, and Safety Precautions are taken (see the following warnings). In addition, note the instrument's external markings which are described under "Safety Symbols."

WARNINGS

Servicing instructions are for use by service-trained personnel only. To avoid dangerous electric shock, do not perform any servicing unless qualified to do so.

BEFORE SWITCHING ON THE INSTRUMENT, the protective earth terminal of the instrument must be connected to the protective conductor of the (mains) power cord. The mains plug shall only be inserted in a socket outlet provided with a protective earth contact. The protective action must not be negated by the use of an extension cord (power cable) without a protective conductor (grounding). Grounding one conductor of a two conductor outlet is not sufficient protection.

If this instrument is to be energized via an auto-transformer (for voltage reduction) make sure the common terminal is connected to the earth terminal of the power source.

Any interruption of the protective (grounding) conductor (inside or outside the instrument) or disconnecting the protective earth terminal will cause a potential shock hazard that could result in personal injury.

Whenever it is likely that the protection has been impaired, the instrument must be made inoperative and be secured against any unintended operation.

Only fuses with the required rated current, voltage, and specified type (normal blow, time delay, etc.) should be used. Do not use repaired fuses or short circuited fuseholders. To do so could cause a shock or fire hazard.

Do not operate the instrument in the presence of flammable gases or fumes. Operation of any electrical instrument in such an environment constitutes a definite safety hazard.

Do not install substitute parts or perform any unauthorized modification to the instrument.

Adjustments described in the manual are performed with power supplied to the instrument while protective covers are removed. Energy available at many points may, if contacted, result in personal injury.

Any adjustment, maintenance, and repair of the opened instrument under voltage should be avoided as much as possible, and when inevitable, should be carried out only by a skilled person who is aware of the hazard involved.

Capacitors inside the instrument may still be charged even if the instrument has been disconnected from its source of supply.

SAFETY SYMBOLS



Instruction manual symbol: the product will be marked with this symbol when it is necessary for the user to refer to the instruction manual in order to protect against damage to the product.



Indicates hazardous voltages.



Earth terminal (sometimes used in manual to indicate circuit common connected to grounded chassis).

WARNING

The WARNING sign denotes a hazard. It calls attention to a procedure, practice, or the like, which, if not correctly performed or adhered to, could result in personal injury. Do not proceed beyond a WARNING sign until the indicated conditions are fully understood and met.

CAUTION

The CAUTION sign denotes a hazard. It calls attention to an operating procedure, practice, or the like, which, if not correctly performed or adhered to, could result in damage to or destruction of part or all of the product. Do not proceed beyond a CAUTION sign until the indicated conditions are fully understood and met.

TABLE OF CONTENTS

**SECTION I
GENERAL INFORMATION**

Introduction..... 1-1

Specifications..... 1-2

Safety Considerations..... 1-2

Instruments Covered By Manual..... 1-2

Description..... 1-2

Options..... 1-3

 Electrical Options..... 1-3

 Mechanical Options..... 1-3

Hewlett-Packard Interface Bus (HP-IB)..... 1-3

 Compatibility..... 1-3

 HP-IB Address..... 1-4

Accessories Supplied..... 1-4

Equipment Available..... 1-4

Recommended Test Equipment..... 1-4

**SECTION II
INSTALLATION**

Introduction..... 2-1

Initial Inspection..... 2-1

Preparation For Use..... 2-1

 Power Requirements..... 2-1

 Line Voltage and Fuse Selection..... 2-2

 AC Power Cable..... 2-3

 HP-IB Address Selection..... 2-3

 Mating Connectors..... 2-4

 Coaxial Connectors..... 2-4

 HP-IB Interface Connector..... 2-4

 Chassis Ground..... 2-4

 Operating Environment..... 2-4

 Bench Operation..... 2-5

 Rack Mounting..... 2-7

Storage and Shipment..... 2-7

 Environment..... 2-7

 Packaging..... 2-7

 Original Packaging..... 2-7

 Other Packaging..... 2-7

TABLE OF CONTENTS (Cont'd)

SECTION III

OPERATION

Introduction.....	3-1
Operating Characteristics.....	3-1
Local Operation.....	3-1
Simplified Operation.....	3-1
Getting Acquainted.....	3-1
Panel Features.....	3-1
Detailed Operating Instructions.....	3-1
Remote Operation.....	3-2
Remote Operation, Hewlett-Packard Interface Bus.....	3-2
Detailed Operating Instructions.....	3-2
Codes and Format Summary.....	3-2
Notation Conventions and Definitions.....	3-2
Operator's Checks.....	3-2
Operator's Calibration and Adjustment.....	3-3
Operator's Maintenance.....	3-3
General Operating Instructions.....	3-3
Power-on.....	3-3
Simplified Operation.....	3-4
Getting Acquainted Exercise.....	3-6
Using Autoscope.....	3-7
Keys and Indications.....	3-7
Changing Values.....	3-7
Using the Trigger Controls.....	3-8
Using Delayed Sweep.....	3-9
Using Delta Volts.....	3-10
Using Delta Time.....	3-10
Using Soft Key Menus.....	3-11
Using Save/Recall.....	3-12
Panel Features.....	3-13
Remote Operation, Hewlett-Packard Interface Bus.....	3-18
HP-IB Compatibility.....	3-18
HP-IB Status Display.....	3-19
Remote Mode.....	3-20
Remote Capability.....	3-20
Local-to-remote Mode Changes.....	3-21
Local Mode.....	3-21
Local Capability.....	3-21
Remote-to-local Mode Changes.....	3-21
Local Lockout.....	3-21
Addressing.....	3-21
Listen-only Mode.....	3-22
Talk-only Mode.....	3-22
HP-IB Turn-on Default Conditions.....	3-22
Data Messages.....	3-23
Receiving the Data Message.....	3-23

TABLE OF CONTENTS (Cont'd)





Input Data Message Format	3-23
Program Order Considerations	3-24
Program Code Format	3-24
Sending the Data Message	3-26
Output Data Message Format	3-26
Learn Mode	3-27
Receiving the Clear Message	3-27
Receiving the Trigger Message	3-28
Receiving the Remote Message	3-28
Receiving the Local Message	3-28
Receiving the Local Lockout Message	3-28
Receiving the Clear Lockout/Set Local Message	3-28
Receiving the Pass Control Message	3-28
Sending the Require Service Message	3-28
Sending the Status Byte Message	3-29
Sending the Status Bit Message	3-30
Receiving the Abort Message	3-31
Operator's Checks	3-32
Confidence Test	3-32
Memory Check	3-33
HP-IB I/O Check	3-33
Address Recognition	3-34
Remote and Local Messages and 	3-34
Receiving the Data Message	3-35
Sending the Data Message	3-35
Local Lockout and Clear Lockout/Set Local Messages	3-36
Abort Message	3-37
Require Service Message	3-37
Status Byte Message	3-38
Operator's Calibration and Adjustment	3-38
Delay Time Self-cal	3-38
Vertical Balance Self-cal	3-39
CRT Adjustments	3-40
Probe Compensation	3-40
Detailed Operating Instructions	3-40
Using the Detailed Operating Instructions	3-40
Advisory Messages	3-42
Autoscope	3-46
Bandwidth Limit	3-49
Calibrator Level	3-50
Character Generator	3-52
Control Knob	3-54
Delay	3-57
Delta Time	3-60
Delta Volts	3-62
Error Messages	3-64
Horizontal Mode	3-66

TABLE OF CONTENTS (Cont'd)

Horizontal Position	3-68
HP-IB Address	3-69
HP-IB Status Advisory	3-70
HP-IB Syntax Errors	3-72
Initialize	3-73
Instrument Status	3-75
Intensity, Characters and Lamps	3-77
Intensity, Trace	3-78
Key	3-79
Learn Mode	3-82
Power-on Sequence and Default Conditions	3-83
Reading Values Via HP-IB	3-84
Save/Recall	3-86
Scope Mode	3-88
Separation, Dual	3-90
Service Request Condition	3-91
Soft Key Menus	3-93
Sweep Mode, Delayed	3-96
Sweep Mode, Main	3-98
Sweep Speed, Delayed	3-100
Sweep Speed, Main	3-102
Text Display	3-104
Trigger, Delayed Sweep	3-107 
Trigger, Main Sweep	3-112 
Trigger Flag	3-117
Trigger View	3-120
Vertical Coupling	3-122 
Vertical Deflection Factor	3-125
Vertical Mode	3-127
Vertical Position	3-129
HP-IB Codes and Format Summary	3-131
HP-IB Capability	3-131
HP-IB Status Advisory	3-131
Address	3-131
General Input Data Message Format	3-131
General Output Data Message Format	3-132
Return to Local	3-132
Default Conditions	3-132
Status Byte	3-132
Notation Conventions and Definitions	3-137

**Sections IV through VIII
 PERFORMANCE TESTS
 ADJUSTMENTS
 REPLACEABLE PARTS
 MANUAL CHANGES
 SERVICE**

These sections are bound separately with a separate table of contents.

LIST OF ILLUSTRATIONS

Figure	Title	Page
1-1	HP Model 1980B Oscilloscope Measurement System and Supplied Accessories	1-0
2-1	Line Voltage Selection Switches	2-2
2-2	Power Cable and Plug Part Numbers	2-3
2-3	Soft Keys and HP-IB ADDRESS MODE CRT Display	2-4
2-4	Hewlett-Packard Interface Cable	2-6
3-1	Front-panel Features	3-4
3-2	Getting Acquainted Exercise Setup	3-6
3-3	The CRT Readout	3-8
3-4	The OPTION MENU Soft Key Definitions	3-11
3-5	Display Panel Features	3-13
3-6	CRT Features	3-13
3-7	Control Panel Features	3-14
3-8	Voltage Panel Features	3-15
3-9	Time Panel Features	3-16
3-10	Rear-panel Features	3-17
3-11	HP-IB Status Advisory	3-20
3-12	1980A/B Input Data Message Examples	3-26
3-13	The Status Byte and the RQS Mask	3-29
3-14	Serial Poll With Require Service Message Disabled (RQS Mask Value = 0)	3-30
3-15	Serial Poll Using the Require Service Message (RQS Mask Value > 0)	3-31
3-16	Divider Probe Adjustment Display	3-41
3-17	Typical Advisory Message Display	3-42
3-18	The 1980A/B CRT Readout	3-52
3-19	The HP-IB Status Advisory	3-70
3-20	Text Field in the 1980A/B CRT Display	3-104
3-21	Maximum Signal Input vs Frequency ≥ 1 kHz	3-108
3-22	Maximum Signal Input vs Frequency ≥ 1 kHz	3-113
3-23	Latched Mode Trigger Flag State Examples	3-117
3-24	Dynamic Mode Trigger Flag State Example	3-117
3-25	Maximum Signal Input vs Frequency ≥ 1 kHz	3-123

LIST OF TABLES

Table	Title	Page
1-1	Specifications	1-5
1-2	Recommended Test Equipment	1-9
1-3	Recommended Test Accesories	1-10
1-4	Alternate Test Equipment	1-10
2-1	Line Fuse Part Numbers	2-2
2-2	ASCII Address Codes to Decimal Equivalents	2-5
3-1	Operating Characteristics	3-3
3-2	Detailed Operating Instructions Index	3-5
3-3	HP-IB Message Reference Table	3-18
3-4	Symbols Used in HP-IB Status Advisory	3-20
3-5	Typical Processing Times for Various Commands	3-25
3-6	Confidence Test Error Messages	3-32
3-7	Advisory Message Description	3-44
3-8	Autoscope and Selective Autoscope Preset Conditions	3-48
3-9	Delay Time Step Resolution (front-panel)	3-57
3-10	Delay Time Accuracy	3-58
3-11	Hardware Error Codes	3-65
3-12	Symbols Used in HP-IB Status Advisory	3-70
3-13	HP-IB Syntax Errors	3-72
3-14	1980A/B Initialized State	3-74
3-15	Key to Keycode Conversion Table	3-80
3-16	Keycode to Key Conversion Table	3-81
3-17	Data Message Output Format	3-85
3-18	Functions Stored in Save/Recall Registers	3-87
3-19	RQS Mask Value for Service Request Conditions	3-91
3-20	Soft Key Menu Tree	3-95
3-21	Special Text Attributes	3-105
3-22	1980A/B Modified ASCII Character Set	3-106
3-23	Trigger View Display Timebase	3-121
3-24	The Status Byte and RQS Mask	3-133
3-25	Program Code Prefix To Function Cross Reference	3-133
3-26	Program Code and Format Summary	3-134
3-27	1980A/B Key Codes	3-135
3-28	1980A/B Text Character Set (Modified ASCII)	3-135
3-29	HP-IB Syntax Error Codes	3-135
3-30	Commonly Used Code Conversions	3-137



Figure 1-1. HP Model 1980B Oscilloscope Measurement System and Supplied Accessories

SECTION I

GENERAL INFORMATION

1-1. INTRODUCTION.

From the standpoint of operation, the Model 1980A and Model 1980B Oscilloscope Measurement Systems are virtually identical; the major difference is in physical configuration. The 1980A is a cabinet model for bench operation. The 1980B is configured for either rack mounted or bench operation. In this manual, the two models are referred to collectively as the 1980A/B. Where distinction is necessary, the two models are referred to separately.

The 1980A/B Operating and Service Manual has eight major sections. The manual contains the following information:

Section I, General Information: describes the instruments documented by this manual. It also provides a basic description of the Measurement System which includes options, accessories, and specifications.

Section II, Installation: provides information about initial inspection, preparation for use (including HP-IB address selection for remote operation), and storage and shipment.

Section III, Operation: provides detailed operating information for the instrument, including remote (HP-IB) operation and operator's checks and maintenance. Also included is a front-panel description and a "getting acquainted" exercise to familiarize the first time user with the basic Measurement System operating procedures.

Section IV, Performance Tests: presents the procedures required to check the performance of the instrument against the critical specifications in table 1-1.

Section V, Adjustments: provides instructions for properly adjusting the instrument.

Section VI, Replaceable Parts: provides ordering information for all replaceable parts and assemblies.

Section VII, Manual Changes: contains manual change information necessary to document all serial prefixes listed on the title page of this manual. In addition, this section also contains recommended modifications for earlier instrument configurations.

Section VIII, Service: provides the information required to repair the instrument.

This Operating and Programming Manual contains Sections I, II, and III only. The Service Manual contains the remaining sections. A second copy of the Operating and Programming Manual is included in the manual set; it should be kept with the instrument for operator reference. Additional copies may be ordered separately through your nearest Hewlett-Packard Sales and Service office. The part numbers for the complete Operating and Service Manual and for the Operating and Programming Manual alone are listed on the title page of this manual.

Also listed on the title page is the part number for a microfiche version of the complete Operating and Service Manual. The microfiche are 100 × 150 mm (4 × 6 inch) microfilm transparencies of the manuals. Each microfiche contains up to 96 photo duplicates of manual pages. The microfiche package also includes the latest Manual Changes supplement.

1-2. SPECIFICATIONS.

Specifications and supplemental characteristics of the 1980A/B Oscilloscope Measurement System are listed in table 1-1. This instrument will meet the electrical characteristics listed following complete calibration as given in the Adjustments section of the manual. These electrical characteristics apply over the ambient temperature range of 0 to 55°C except as otherwise noted. Warm-up time for given accuracy is 30 minutes.

1-3. SAFETY CONSIDERATIONS.

**WARNING**

To prevent personal injury, observe all safety precautions and warnings stated on the instrument and in the manual.

This product is a Safety Class I instrument (provided with a protective earth terminal). The 1980A/B and all related documentation must be reviewed for familiarization with safety markings and instructions before operation. Refer to the Safety Considerations page found at the beginning of this manual for a summary of general safety information. Safety precautions for installation, operation, and servicing are found in appropriate locations throughout the Operating and Service Manual. These precautions must be observed during all phases of operation, service, and repair of this instrument. Failure to comply with these precautions or with specific warnings elsewhere in the manual violates safety standards of design, manufacture, and intended use of this instrument. Hewlett-Packard assumes no liability for failure to comply with these requirements.

1-4. INSTRUMENTS COVERED BY MANUAL.

Attached to the instrument is a serial number plate. The serial number is in the form: 0000A00000. It is in two parts: the first four digits and the letter are the serial number prefix and the last five digits are the suffix. The prefix is the same for all identical instruments; it changes only when a change is made to the instrument. The letter in the prefix designates the country in which the instrument was manufactured. (A=USA; G=West Germany; J=Japan; S=Singapore.) The suffix, however, is assigned sequentially and is unique to each instrument. The contents of this manual apply to instruments with the serial number prefix(es) listed under SERIAL NUMBERS on the title page.

An instrument manufactured after the printing of this manual may have a serial number prefix that is not listed on the title page. This unlisted serial number prefix indicates the instrument is different from those described in this manual. Manuals accompanying these newer instruments include a Manual Changes supplement. The supplement contains change instructions for the entire Operating and Service Manual.

In addition to change information, the supplements may contain information for correcting errors in the manuals. To keep your manuals as current and accurate as possible, Hewlett-Packard recommends that you periodically request the latest Manual Changes supplement. These supplements are identified with the print date and part number that appears on the title page of this manual. Complimentary copies of these supplements are available from Hewlett-Packard.

For information concerning a serial number prefix that is not listed on the title page or in the Manual Changes supplement, contact your nearest Hewlett-Packard Sales and Service office.

1-5. DESCRIPTION.

The 1980A/B Oscilloscope Measurement System is a complete two channel 100 MHz oscilloscope. It features 2 mV/div deflection factor, two independent 5 nsec/div sweeps, main and delayed trigger view, and both delta time and delta voltage functions. Measurement capabilities can be extended by adding internal options and plug-in Expansion Modules.

In addition, the 1980A/B has these special features:

- * All functions are programmable via HP-IB (HP's implementation of IEEE Std 488) for automatic or semi-automatic measurement applications.
- * Autoscope function presets the 1980A/B, then autoranges trigger level, deflection factor, and sweep speed. It provides a one keystroke setup for most input signals.
- * Save/Recall registers can be used to save as many as eight complete instrument states for recall in repetitive measurement procedures.
- * Calibration can be performed on-site, without removing covers and requires little or no test equipment. Internal reference signals are provided and complete, step by step instructions are displayed on the CRT.

1-6. OPTIONS.

1-7. Electrical Options.

Option 080: Supplies two, 10080A 10:1, 1 M (3.3 ft) probes instead of two 10081A probes.

Option 082: Supplies two, 10082A 10:1, 3 M (10 ft) probes instead of two 10081A probes.

Option 083: Supplies two, 10083A 1:1, 1 M (3.3 ft) probes instead of two 10081A probes.

Option 084: Supplies two, 10084A 1:1, 2 M (6.5 ft) probes instead of two 10081A probes.

Option 090: Deletes probes.

Option 150: Supplies HP Model 1950A Two Channel Vertical Plug-in installed in the 1980A/B.

Option 810: Supplies HP Model 19810A Key Sequence ROM installed in the 1980A/B.

1-8. Mechanical Options.

The following options are available for rack mounting the 1980B. The rack mounting kits can be ordered separately from the nearest Hewlett-Packard Sales office using the part numbers given in the descriptions.

Rack Flange Kit (Option 908). This kit contains flanges and hardware for mounting the Measurement System in a standard rack of 482.5 mm (19 inches). Order HP part number 5061-0077.

Rack Flange and Front Handle Combination Kit (Option 909). This kit contains flanges, handles and mounting hardware (the flanges are different than the Option 908 flanges). Order HP part number 5061-0083.

Standard Slide Kit (Option 009). This kit contains rack mounting slides and hardware for mounting the Measurement System into HP rack enclosures. Order HP part number 1494-0017.

1-9. HEWLETT-PACKARD INTERFACE BUS (HP-IB).



1-10. Compatibility.

The standard 1980A/B Oscilloscope Measurement System has an HP-IB interface and can be used in automatic system applications driven by an HP-IB equipped controller or computer. The instrument is fully programmable via the HP Interface

Bus. The instrument's compatibility with HP-IB is defined by the following list of interface functions: SH1, AH1, T5, TEO, L3, LEO, SR1, RL1, PPO, DC0, DT1, CO, E2. For an explanation of the compatibility codes, refer to IEEE Std 488, "IEEE Standard and Digital Interface for Programmable Instrumentation" or the identical ANSI Standard MC1.1.

For more detailed information relating to remote operation of the Measurement System, refer to Remote Operation, Hewlett-Packard Interface Bus in Section III of this manual.

1-11. HP-IB Address.

The HP-IB address "7" is preset at the factory before the instrument is shipped. This address may be displayed or changed from the front-panel when the HP-IB ADDRESS MODE menu is selected. This procedure is described in Section II. The "HP-IB Address" Detailed Operating Instruction (Section III) provides a more complete description of addressing considerations.

1-12. ACCESSORIES SUPPLIED.

Accessories supplied with the Measurement System are in figure 1-1. Included with the instrument are: One blue light filter, one 2.3 M (7.5 ft) power cordset, one Expansion Module Panel Cover, and one complete Operating and Service Manual. A second copy of the Operating and Programming Manual (sections I-III) is also included.

The power cable and line fuse are selected at the factory according to the voltage available in the country of destination. For the part numbers of the available power cables, refer to paragraph 2-6, AC Power Cable, in Section II.

1-13. EQUIPMENT AVAILABLE.

The following accessories are available for servicing the Measurement System:

64 Pin Hybrid Extender. Aids troubleshooting circuits containing 64 pin hybrids. Order HP part number 5081-7663.

Plug-in Extender. Required to service plug-in Expansion Modules. Order HP part number 01980-63901.

1-14. RECOMMENDED TEST EQUIPMENT.

Table 1-2 lists equipment required for maintaining the 1980A/B. The Critical Specifications column describes the essential requirements for each piece of test equipment. Other equipment can be substituted if it meets or exceeds these critical specifications.

The Suggested Model column may suggest more than one model. The first model shown is usually the least expensive, single purpose model. Alternate models are suggested for additional features that would make them a better choice in some applications. For example, reasons for recommending an alternative model might be:

- * HP-IB programmability
-- or --
- * Multi-function capability (that is, one model can replace two or more single purpose models)

Table 1-4 presents the advantages of the alternate suggestions.

Table 1-1. Specifications (Page 1 of 4)

OPERATING MODES

Voltage vs time (V vs T); channel 1 vs 2 (1 vs 2); monitor mode for logic state display with HP Model 1607A (X·Y·Z).

VERTICAL DISPLAY MODES (V vs T)

Channel 1; channel 2; channels 1 and 2 displayed on alternate sweeps (ALT); channels 1 and 2 displayed by switching between channels at approx 400 kHz rate with blanking during switching (CHOP); automatic selection of alternate for sweep speeds >1 ms/div and chop for sweep speeds ≤1 ms/div (AUTO-CHOP/ALT); channel 1 plus 2 algebraic addition (1+2), channel 1 and/or 2 may be inverted; and either main or delayed trigger signal.

VERTICAL AMPLIFIERS (2)

BANDWIDTH: 3 dB down from a 5 div reference signal (0 to +40° C).

DC-Coupled: dc to 100 MHz in 50Ω and 1 MΩ input modes.

AC-Coupled: <10 Hz to ≥100 MHz.

BANDWIDTH LIMIT: limits upper bandwidth to approx 20 MHz.

INPUT COUPLING: AC, DC, 50Ω (DC), Ground. Ground position disconnects input connector and grounds amplifier input.

INPUT RC

AC or DC: 1 MΩ ±2% shunted by approx 16 pF.

50 Ohm (DC): 50Ω ±3%.

MAXIMUM INPUT VOLTAGE

50 Ohm: 5V rms.

1 Megohm: ac or dc coupled, 250V (dc + peak ac) at ≤1 kHz.

DEFLECTION FACTOR

Range: 2 mV/div to 10 V/div.

Resolution: 3 digits.

Adjustment: coarse stepping is in a 100, 150, 200, 300 . . . 900 sequence; fine stepping is a change of 1 in the least significant digit.

Accuracy: ±3%.

VERTICAL POSITION

Range: baseline can be adjusted ±15 major div from center graticule line (possible 10 div off screen).

Resolution: 0.02 major division.

Adjustment: coarse or fine slew rates.

Accuracy: ±(2% of reading +0.3 major div).

ΔV (CHANNEL 1 OR 2)

Range: ±15 times the deflection factor selected for that channel.

Resolution: 0.02 times the deflection factor for that channel.

Adjustment: coarse or fine slew rates.

Accuracy: ±4% (for a Δ ≤ 10 major divisions).

CHANNEL 1 + 2

Amplifier: bandwidth and deflection factors are unchanged.

Differential (Channel 1-2 or Channel 2-1): CMR is at least 20 dB from dc to 20 MHz with common mode signal amplitude equivalent to 10 div and one channel adjusted for optimum rejection.

TRIGGER VIEW

Display: internal or external trigger signal for either main or delayed sweep.

Deflection Factor: internal, approx deflection for selected channel; ext ÷ 10, 600 mV/div ±20%; ext ÷ 1, 60 mV/div ±20%.

External Trigger Signal Delay: ≤4 ns with identically timed signals to a vertical channel and either main or delayed trigger inputs.

Trigger Point: approx center horizontal graticule line.

Momentary: trigger signal is displayed while main or delayed trigger level is adjusted.

HORIZONTAL DISPLAY MODES (V vs T)

Main, Main Intensified, Delayed, and Dual. Dual simultaneously displays main intensified and delayed sweep for all displayed channels.

MAIN AND DELAYED TIME BASES

RANGE: 5 ns/div to 1 s/div.

RESOLUTION: 3 digits.

ADJUSTMENT: coarse stepping is in a 100, 200, 300, . . . 900 sequence; fine stepping is a change of 1 in the least significant digit.

ACCURACY:

Speed	Accuracy*
5 ns/div to 9.99 ns/div (center 8 div)	±3%
10 ns/div to 9.99 ms/div (first 10 div)	±3%
10 ms/div to 1 s/div (first 10 div)	±4%

*Within ±10° C of the temperature at which the instrument was calibrated. For temperatures beyond the ±10° C range and within 0 to +55° C, add 1%, from 0.5 s/div to 1 s/div add 2%.

SWEEP DELAY

Delay can be measured by either time or a number of events.

TIME DELAY

RANGE: 0 to 9.9999 s.

Resolution: displayed, 5 digits; HP-IB, 100 ps at any delay, possible 11 digits.

Table 1-1. Specifications (Page 2 of 4)

Accuracy:*

Delay or Time Interval

Sweep Speed	<200 μ s	\geq 200 μ s
5 ns/div to 9.99s/div	$\pm(2 \text{ ns} + 0.1\% \text{ of reading})$	$\pm(0.05\% \text{ of reading})$
$\geq 10 \text{ ns/div}$	$\pm(2 \text{ ns} + 0.1\% \text{ of reading} + 1\% \text{ of dly'd s/div} \times 10 \text{ div})$	$\pm(0.05\% \text{ of reading} + 1\% \text{ of dly'd s/div} \times 10 \text{ div})$

*Within one hour of a Delay Self Calibration and in constant ambient temperature.

Delay Jitter: 0.002% of delay time; at 10 MHz \pm 10 kHz, 0.01% of delay time.

Adjustment: Numerical, step size is related to current delay value; Normal, step size is related to sweep speed.

TIME INTERVAL (Δ T)

A zero time reference can be set anywhere in the delay range and a time interval measurement can be made from that point.

Resolution, Adjustment, Accuracy: same as Time Delay.

FREQUENCY (1/ Δ T)

Calculates and displays reciprocal of time interval measurement.

Resolution: same as Δ T. As frequency increases insignificant digits are truncated.

Adjustment, Accuracy: same as Time Delay.

DIGITAL DELAY

Range: 0 to $10^8 - 1$ events.

Resolution: 1 event.

Adjustment: coarse stepping is in a 1, 2, 3, . . . 9, 10, 20, 30, . . . 90, etc. sequence; fine stepping is a change of 1 in least significant digit.

Maximum Rep Rate: 15 MHz with a 50% duty cycle.

TRIGGERING (Main and Delayed Time Bases)

MAIN SWEEP

Triggered: specified level and slope is required to generate a sweep.

Auto-Triggered: baseline displayed in absence of a trigger signal; triggering is same as triggered above approx 10 Hz.

Single: sweep occurs once with same triggering as Triggered mode; reset key rearms sweep.

DELAYED SWEEP

Auto Sweep After Delay: delayed sweep starts at end of delay time.

Triggered Sweep After Delay: delayed sweep can be triggered after delay time.

Digital Delay: delayed sweep starts a specified number of events after start of main sweep.

SOURCES

Selectable from Channel 1, Channel 2, Enhancement Module, or External. Line frequency triggering is also available for main sweep only. Main and delayed trigger sources are independently selectable.

INTERNAL TRIGGER LEVEL

Range: ± 20 major divisions from center horizontal graticule line.

Resolution: 0.02 major divisions; coarse or fine slew rates.

Accuracy: $\pm(3\% \text{ of reading} + 0.4 \text{ major div})$.

EXTERNAL TRIGGER LEVEL

Range: $\div 1, \pm 1.2 \text{ V}$ from ground reference; in $\div 10, \pm 12 \text{ V}$ from ground reference.

Resolution: $\div 1, 2 \text{ mV}$; in $\div 10, 20 \text{ mV}$; coarse or fine slew rates.

Accuracy: $\pm(3\% \text{ of reading} + 40 \text{ mV})$; in $\div 10$ mode, $\pm(3\% \text{ of reading} + 400 \text{ mV})$.

LINE TRIGGER LEVEL

Range: ± 20 relative units.

Resolution: steps of 0.02; fine or coarse slew rates.

SLOPE: triggers on positive or negative slope within specified trigger signal range.

SENSITIVITY

Internal: for deflection factors $< 10 \text{ mV/div}$, at least 1.4 div of vertical deflection from dc to 25 MHz increasing to 3 div at 100 MHz; for deflection factors $\geq 10 \text{ mV/div}$ at least 0.7 div of vertical deflection from dc to 25 MHz increasing to 1.5 div at 100 MHz.

External: in external $\div 10$, at least 500 mV p-p from dc to 25 MHz increasing to 1.2 V p-p at 100 MHz; in external $\div 1$, at least 50 mV p-p from dc to 25 MHz increasing to 120 mV p-p at 100 MHz.

COUPLING (Internal and External)

AC: attenuates signals $< 10 \text{ Hz}$.

DC: direct coupled.

HF Rej: attenuates signals above approx 35 kHz.

LF Rej: attenuates signals below approx 35 kHz.

EXTERNAL TRIGGER INPUTS (Main and Delayed)

Input RC: AC or DC, $1 \text{ M}\Omega \pm 2\%$ shunted by approx 15 pF; 50Ω (DC), $50\Omega \pm 3\%$.

Maximum Input Voltage: 50Ω (DC), 5 V rms; $1 \text{ M}\Omega$, ac or dc coupled, 250 V (dc + peak ac) at $\leq 1 \text{ kHz}$.

1 vs 2 OPERATION

BANDWIDTH

Y-Axis (Channel 1): same as channel 1 in V vs T.

X-Axis (Channel 2): dc to 4 MHz.

Phase Difference Between Channels: $\leq 3^\circ$ dc to 100 kHz.

Deflection Factors: same as Vertical Amplifiers.

X·Y·Z OPERATION

Inputs are compatible with HP Model 1607A Logic State Analyzer or equivalent.

X AND Y INPUTS

Deflection Factors: 0.5 V/div $\pm 20\%$ for X; 0.4 V/div $\pm 20\%$ for Y.

Table 1-1. Specifications (Page 3 of 4)

Input Impedance: approx 5 k Ω .

Maximum Input Voltage: ± 10 V.

Z-INPUT

Sensitivity: pulse ≥ 50 ns wide and 4 V amplitude blanks any intensity display.

Input Impedance: low power Schottky TTL gate.

Bandwidth: approx 10 MHz.

Maximum Input Voltage: TTL level, 5 V.

CATHODE-RAY TUBE AND CONTROLS

TYPE: post accelerator, approx 22 kV accelerating potential, aluminized P31 phosphor.

GRATICULE: 10 \times 10 div internal graticule; 0.2 sub-division markings on major horizontal and vertical axes; 10 \times 12 cm display area.

TRACE INTENSITY: adjustable in relative steps of 1 from 0 to 99.

CHARACTER INTENSITY: adjustable in relative steps of 1 from 0 to 99.

FIND BEAM: returns trace to CRT screen regardless of setting of vertical, horizontal, or intensity controls.

GRATICULE ILLUMINATION: internal flood gun.

ALIGN: aligns baseline with horizontal graticule line.

ASTIG: controls roundness of beam.

OPERATING CHARACTERISTICS

AUTOSCOPE: seeks, scales, and displays input signals >20 mV and >50 Hz. Autoscope preselects V vs T operating mode, main sweep, assigns Control Knob to main sec/div, ac input coupling, character generator on, internal trigger source, positive slope, and trigger level to 0.5 div.

SELECTIVE AUTOSCOPE: seeks, scales, and displays selected channels in the same manner as oscilloscope except all setup functions below the variable function keys on the "VOLTAGE" and "TIME" panels are preserved.

PROBE RECOGNITION: deflection factor, ΔV , or external trigger level readout is automatically adjusted for division ratio of recommended 1:1 or 10:1 probes.

SAVE/RECALL REGISTERS: saves up to eight complete front panel setups in nonvolatile memory.

PRESET: sets front panel to V vs T, intensified sweep mode, 100 μ s/div main sweep, 10 μ s/div delayed sweep, channel 1 main trigger, channel 1 delayed trigger, 2 V/div on channels 1 and 2, and ac input coupling.

CRT DISPLAY READOUTS: displays selected trigger source and selected variable functions.

Trigger Source: time base, main or delayed for channels 1 and 2, external, and line.

Variable Functions: channels 1 and 2 volts/div and ΔV ; main and delayed sweep speeds; time delay, normal, numerical, and digital; normal and numerical ΔT ; and calculated frequency (reciprocal of ΔT) $1/\Delta T$.

LED DISPLAY READOUTS: all functions related to the Control Knob are displayed.

HORIZONTAL POSITION

Range: ± 6 major div from center vertical graticule line.

Resolution: 0.02 major divisions.

Adjustment: coarse or fine slew rates.

DUAL SEPARATION

Range: delayed sweep waveform can be adjusted ± 5 major vertical div from main sweep waveform.

Resolution: 0.02 major divisions.

Adjustment: coarse or fine slew rates.

PANEL INTENSITY: adjustable in relative steps of 1 from 0 to 99.

GENERAL

BUS COMPATIBILITY: as defined in IEEE Std 488-1978 is: SH1, AH1, T5, TE0, L3, LEO, SR1, RL1, PPO, DC0, DT1, C0, and E2.

SELF CALIBRATION ROUTINES: two self calibration routines can be performed at any time without altering front panel setup.

Balance Self Cal: DC balances vertical pre-amplifier inputs to minimize trace shift during deflection factor range changes.

Delay Self Cal: calibrates delay time oscillator to within 0.005% of the internal crystal reference accuracy.

FRONT PANEL CAL 1980A/B: Channel 1 and 2 position, dual separation, main and delayed-trigger level, and delay time are calibrated to specified accuracy using internally generated calibration signals. Channel 1 and 2 deflection factors, and main and delayed sweep speeds are calibrated to specified accuracies with externally supplied calibration signals. Deflection factors and sweep speeds are also supplied with internal calibration signals as a performance verification with approx $\pm 6\%$ accuracy.

SIGNAL OUTPUTS

Calibrator Outputs: rear panel BNC and front panel post: source impedance, approx 150 Ω ; probe calibration, 1 V p-p $\pm 1\%$, approx 1.86 kHz square wave, rise time ≤ 5 μ s; programmable cal signals, 20 mV p-p $\pm 2\%$, 100 mV p-p $\pm 1\%$, 200 mV p-p $\pm 1\%$, 1 V p-p $\pm 1\%$, and 10 V p-p $\pm 1\%$.

15 Volt Reference: source impedance, approx 1 k Ω ; level, 15 V ± 30 mV.

Main Gate: source impedance, ECL gate output; signal, high ECL logic level following main gate.

Delayed Gate: source impedance, ECL gate output; signal, high ECL logic level following delayed gate.

POWER: 100, 120, 220, 240 Vac, +5 to -10%, 48 to 440 Hz, 300 VA max with expansion module and plug-in ROMs, standard, 200 VA max.

OPERATING ENVIRONMENT

Temperature: 0 to +55 $^{\circ}$ C.

Humidity: to 95% relative at +40 $^{\circ}$ C.

Altitude: to 4600 m (15 000 ft).

Vibration: vibrated in three planes for 15 min. each with 0.38 mm (0.015 in.) excursion, 10 to 55 Hz.

Table 1-1. Specifications (Page 4 of 4)

ACCESSORIES FURNISHED: one blue light filter HP P/N 01980-02701, one 2.3 m (7.5 ft) power cord, one Expansion Module Panel Cover HP P/N 01980-24106, two Operating/Programming Manuals, one Service

Manual, one Binder with Divider tabs, two 10081A, 10:1, divider probes approx 2 m (6 ft) long.
WEIGHT: net, approx 18.2 kg (40 lb); shipping, approx 24.1 kg (53 lb).

DIMENSIONS:

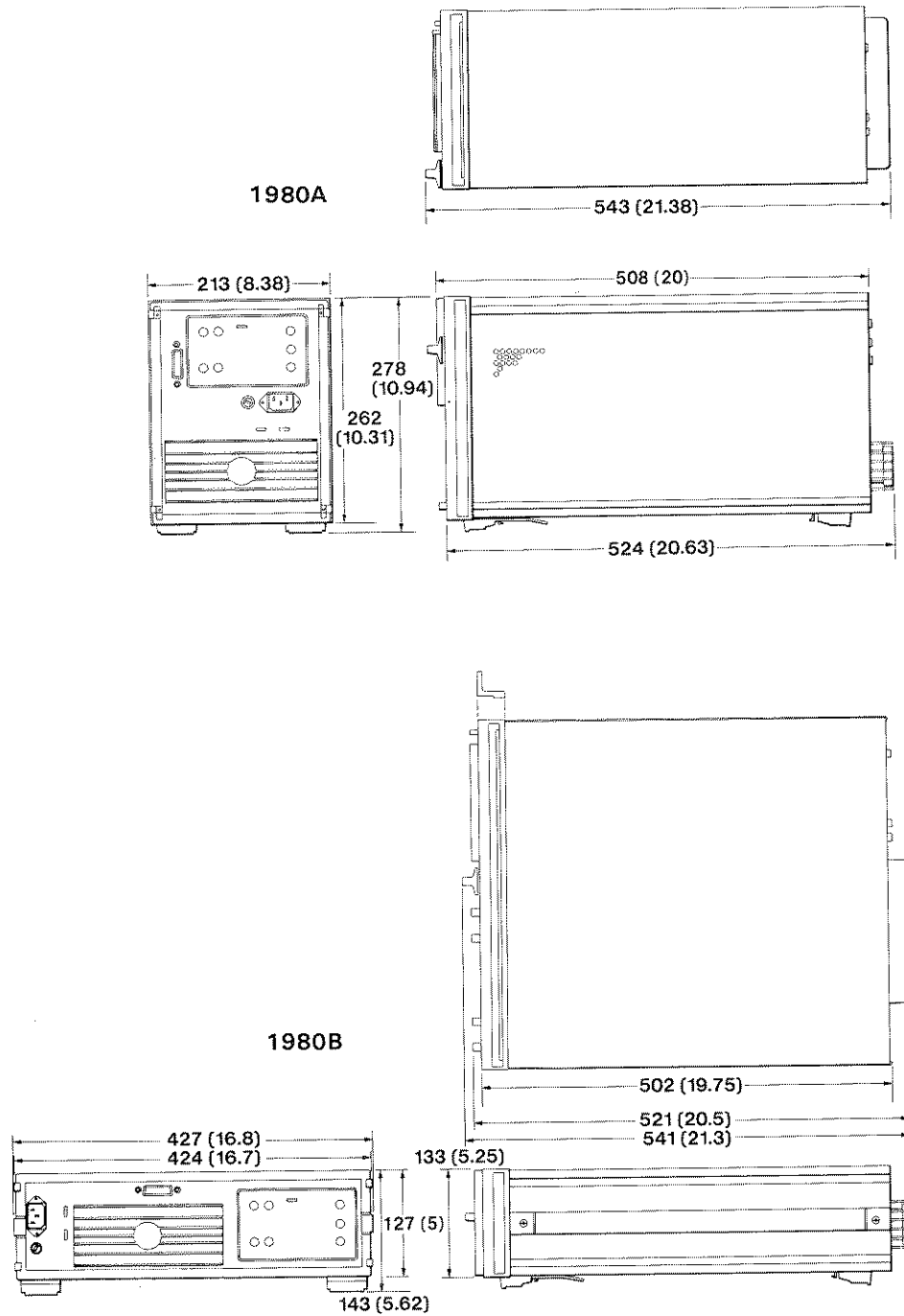

Table 1-2. Recommended Test Equipment

Instrument	Critical Specifications	Suggested Model	Use*
Cable Pair	50 ohm BNC male to BNC male, approximately 9 inches long. Pair must be of equal length.	HP 10502A	P
Controller, HP-IB	HP-IB compatibility as defined by IEEE Std 488 and the identical ANSI Std MC1.1: SH1, AH1, T2, TE0, L2, LEO, SRO, PPO, DCO, DT0, and C1, 2, 3, 4, 5.	HP 9825B with 98034A (revised) -or- HP 9835A with 98332A I/O ROM and 98034A (revised) -or- HP 85F	C,T
DC Source	level: 0 to 100 Vdc accuracy: $\pm 0.25\%$	Ballantine 6125B	A,T
Digital Voltmeter (DVM)	range: 0 to 100 Vdc accuracy: $\pm 0.1\%$ input impedance: 10 Mohm	HP 3465A -or- HP 3438A	A,T
Electronic Counter	range: 0 to 10 MHz resolution: 8 digit accuracy: ± 0.1 Hz	HP 5382A	A,T
Function Generator	range: 10 Hz to 100 kHz squarewave 2 kHz to 50 kHz sinewave level: 0 to 10 Vp-p	HP 3310A	A,T
LCR Meter	range: 3 pF to 20 pF accuracy: $\pm 5\%$	HP 4332A	A
Oscilloscope	2 channels, delayed sweep (sensitivity:) 5 mV/div bandwidth: 100 MHz	HP 1740A	A,P,T
Peak to Peak Source	level: 20 mV to 100 V accuracy: $\pm 0.25\%$	Ballantine 6125B	A,P,T
Power Divider	1- 50 ohm input 2- 50 ohm outputs	General Radio 874-TPDL	P
Probe	input R: 1M ohm shunt C: 12 pF division ratio: 10:1 comp. range: 20 to 26 pF	HP 10041A	A,P,T
Probe, High Voltage	division ratio: 1000:1 (into 10 Mohm DVM input)	HP 34111A	A,T
Sampling Voltmeter	bandwidth: 10 MHz to 100 MHz accuracy: $\pm 3\%$	HP 3406A with HP 11063A Sampling Tee	P
Signal Generator	range: 10 MHz to 100 MHz	HP 3200B	P,T
Signature Analyzer	No Substitute	HP 5004A	T
Time Mark Generator	range: 5 nsec to 1 sec accuracy: $\pm 0.01\%$	Ballantine 6125B	A,P,T

* A = Adjustments, C = Operator's Checks, P = Performance Testing, T = Troubleshooting

Table 1-3. Recommended Test Accessories

Accessory Type		Qty	Suggested Part
Adapter	GR874 to female BNC	4	HP 1250-0850
Adapter	GR874 to male BNC	1	HP 1250-0849
Tee	BNC, coaxial, one male, two female connectors	1	HP 1250-0781

Table 1-4. Alternate Test Equipment

Instrument Type	Suggested Alternate	Instrument Replaced	Advantages of Alternate
Controller, HP-IB	HP 9835A with 98332A and 98034A (revised)	HP 9825B with 98213A and 98034A (revised)	CRT Display HP Enhanced BASIC Larger Memory
	HP 85F	HP 9825B with 98034A (revised) 98213A	CRT Display HP Extended BASIC Lower Cost
Digital Voltmeter (DVM)	HP 3438A	HP 3465A	HP-IB*

* HP-IB is Hewlett-Packard's implementation of IEEE Std 488 and the identical ANSI Std MC1.1.

SECTION II

INSTALLATION

2-1. INTRODUCTION.

This section provides installation instructions for the Measurement System. Also included is information pertinent to initial inspection, preparation for use, storage, and shipment.

2-2. INITIAL INSPECTION.

WARNING

To avoid hazardous electrical shock, do not perform electrical tests when there are signs of shipping damage to any portion of the outer enclosure (covers and panels).

Inspect the shipping container for damage. If the shipping container or cushioning material is damaged, it should be kept until the contents of the shipment have been checked mechanically and electrically. The contents of the shipment should be as shown in figure 1-1. Procedures for checking electrical performance are given in the Operator's Checks in Section III and Performance Tests in Section IV. If the contents are incomplete, if there is mechanical damage or defect, or if the instrument does not pass the electrical performance test, notify the nearest Hewlett-Packard Sales and Service office. If the shipping container is damaged, or the cushioning materials show signs of stress, notify the carrier as well as the Hewlett-Packard office. Keep the shipping materials for the carrier's inspection.

2-3. PREPARATION FOR USE.

2-4. Power Requirements.

The Measurement System requires a power source of 100, 120, 220, or 240 Vac $\pm 5\%$ –10%; 48-440 Hz single phase. Power consumption is 200 VA maximum; with an expansion module and plug-in ROMs installed, power consumption is 300 VA maximum.

WARNING

This is a Safety Class I product (provided with a protective earth terminal). An uninterruptible safety earth ground must be provided from the main power source to the product input wiring terminals, power cord, or supplied power cord set. Whenever it is likely that the protection has been impaired, the instrument must be made inoperative and be secured against any unintended operation.

If this instrument is to be energized via an autotransformer for voltage reduction, make sure the common terminal is connected to the earthed pole of the power source.

2-5. Line Voltage and Fuse Selection.

WARNING

For protection against fire hazard, the line fuse should only be replaced with 250 V, fast blow fuses with the correct current rating.

CAUTION

BEFORE CONNECTING THIS INSTRUMENT to line (Mains) voltage, be sure the line voltage switches are set correctly and that the proper fuse is installed.

If the line fuse burns out, do not replace it until the cause for failure has been determined and repaired by a qualified service person only. Replacing this fuse in a damaged instrument can cause additional damage.

The line voltage switch settings and line fuse are selected at the factory according to the line (Mains) voltage available in the country of destination. To operate the instrument from any other power source, proceed as follows:

- a. Disconnect power cord.
- b. Using a blade-type screwdriver, position rear-panel LINE voltage select switches for desired Vac input. (Figure 2-1 shows switches set for 120 Vac operation.)
- c. Select and install proper line fuse. Fuse current ratings are printed on the LINE module on the instrument's rear panel and are listed with HP part numbers in table 2-1.
- d. Reconnect power cord.

Table 2-1. Line Fuse Part Numbers

Line Voltage	Fuse Rating	HP Part Number
100/120 Vac	250 V, 3 A Fast blow	2110-0003
220/240 Vac	250 V, 1.5 A Fast blow	2110-0043

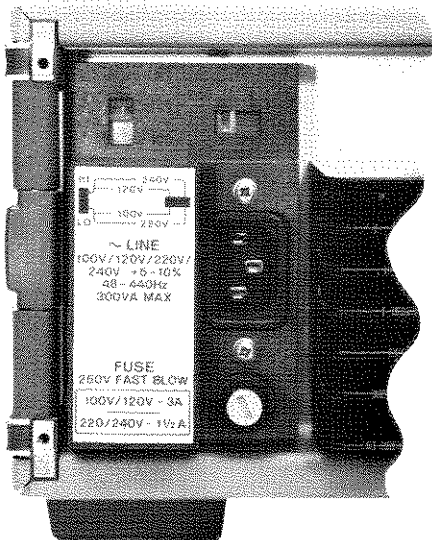

Figure 2-1. Line Voltage Selection Switches

2-6. AC Power Cable.

WARNING

BEFORE CONNECTING THIS INSTRUMENT, the protective earth terminal of the instrument must be connected to the protective conductor of the (Mains) power cord. The Mains plug must be inserted in a socket outlet provided with a protective earth contact. The protective action must not be negated by the use of an extension cord (power cable) without a protective conductor (grounding). Grounding one conductor of a two conductor outlet does not provide an instrument ground.

This instrument is equipped with a three-wire power cable. When connected to an appropriate power receptacle this cable grounds the instrument cabinet. The type of power cable plug shipped with each instrument depends on the country of destination. Figure 2-2 shows the part numbers (and associated Option numbers) for the power cables and plug configurations available.

<p>Option 900</p>  <p>Plug: BS 1363A HP 8120-1703</p>	<p>United Kingdom 250 V</p>	<p>Option 901</p>  <p>Plug: NZSS 198/AS C112 HP 8120-0696</p>	<p>Australia/ New Zealand 250 V</p>	<p>Option 902</p>  <p>Plug: CEE7-VII HP 8120-1692</p>	<p>European Continent 250 V</p>	<p>Option 903</p>  <p>Plug: NEMA 5-15P HP 8120-1521</p>	<p>USA/ Canada 125 V</p>
<p>Option 904</p>  <p>Plug: NEMA 6-15P HP 8120-0698</p>	<p>USA/ Canada 250 V</p>	<p>Option 905</p>  <p>Plug: CEE 22-VI HP 8120-2191</p>	<p>Systems 250 V</p>	<p>Option 906</p>  <p>Plug: SEV 1011.1959-24507 HP 8120-2296</p>	<p>Switzerland</p>	<p>Option 912</p>  <p>Plug: DHCR 107 HP 8120-2956</p>	<p>Denmark 220 V</p>
<p>NOTE: The number listed for the plug is the industry identifier for the plug only. The HP part number specifies a complete power cordset.</p>							

Figure 2-2. Power Cable and Mains Plug Part Numbers



2-7. HP-IB Address Selection.

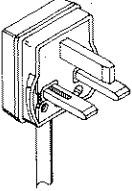
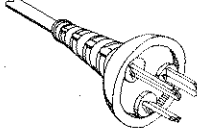
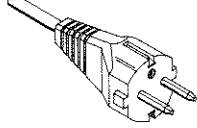
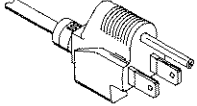
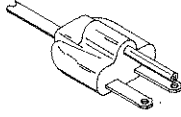
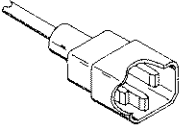
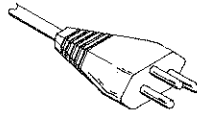
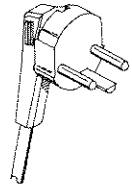

The HP-IB address is displayed or changed using the keys located on the left hand side of the CRT (refer to figure 2-3). To check the address setting, set the Measurement System LINE switch to ON and press **OPTION MENU**, then **5** **19842A** HP-IB.

This calls the **HP-IB ADDRESS MODE** menu (refer to figure 2-3). The current instrument address is on the second line of the display in decimal code. (Address "7" is preset at the factory.) Table 2-2 lists the decimal equivalents of the ASCII Talk and Listen codes. For a more complete listing of ASCII code equivalents, refer to table 3-30.

To change the HP-IB address, press:

3  INCREMENT or 4  DECREMENT

When the desired address is displayed, press .

Note

The HP-IB address is stored in nonvolatile memory. Therefore, the address value is not affected by power-down. It can only be changed through the front-panel key sequence.

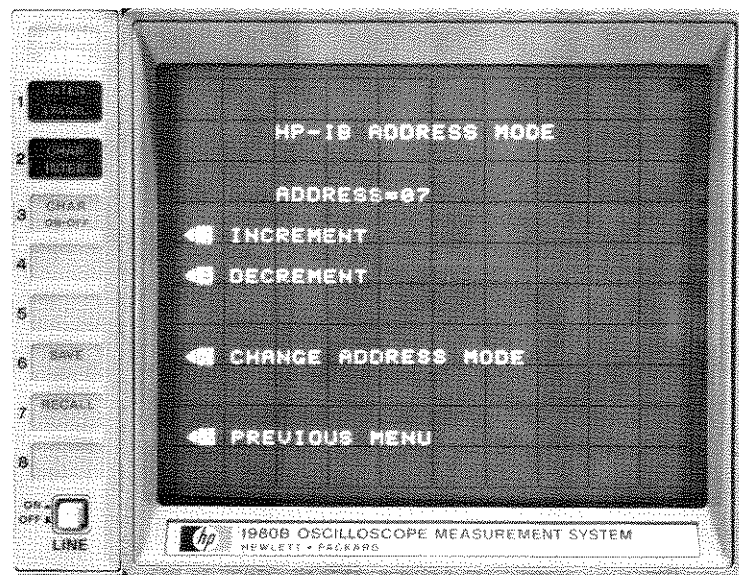

Figure 2-3. The Soft Keys and the HP-IB ADDRESS MODE Menu

2-8. Mating Connectors.

Coaxial Connectors. Coaxial mating connectors used with the Measurement System should be 50 ohm BNC male connectors.

HP-IB Interface Connector. Interconnection data for the Hewlett-Packard Interface Bus is provided in figure 2-4.

Chassis Ground. The front-panel chassis ground jack will accept a standard banana plug. The rear-panel chassis ground binding post accepts a standard banana plug or an 18 gauge wire.

2-9. Operating Environment

CAUTION

Do not block the instrument fan or ventilation holes. At minimum, 1/16 inch (0.2 cm) clearance should be provided around the top, bottom, and sides of the instrument.



Table 2-2. ASCII Address Codes to Decimal Equivalents

ASCII Address Codes		Decimal Equivalents
LISTEN	TALK	
SP	@	00
!	A	01
"	B	02
#	C	03
\$	D	04
%	E	05
&	F	06
.	G	07†
(H	08
)	I	09
*	J	10
+	K	11
,	L	12
-	M	13
.	N	14
/	O	15
0	P	16
1	Q	17
2	R	18
3	S	19
4	T	20
5	U	21
6	V	22
7	W	23
8	X	24
9	Y	25
:	Z	26
;	[27
<	\	28
=]	29
>	^	30

† Indicates factory set address.

The operating environment should be within the following limitations:

- Temperature 0°C to +55°C
- Humidity < 95% relative at 40°C
- Altitude < 4570 metres (15 000 feet)

2-10. Bench Operation.

The 1980A and 1980B cabinets have plastic feet and fold-away tilt stands for convenience in bench operation. The plastic feet are shaped to ensure positive alignment when the Measurement System is stacked with other instruments housed in Hewlett-Packard System I or System II enclosures. The tilt stands raise the front of the instrument for easier viewing of the front-panel.

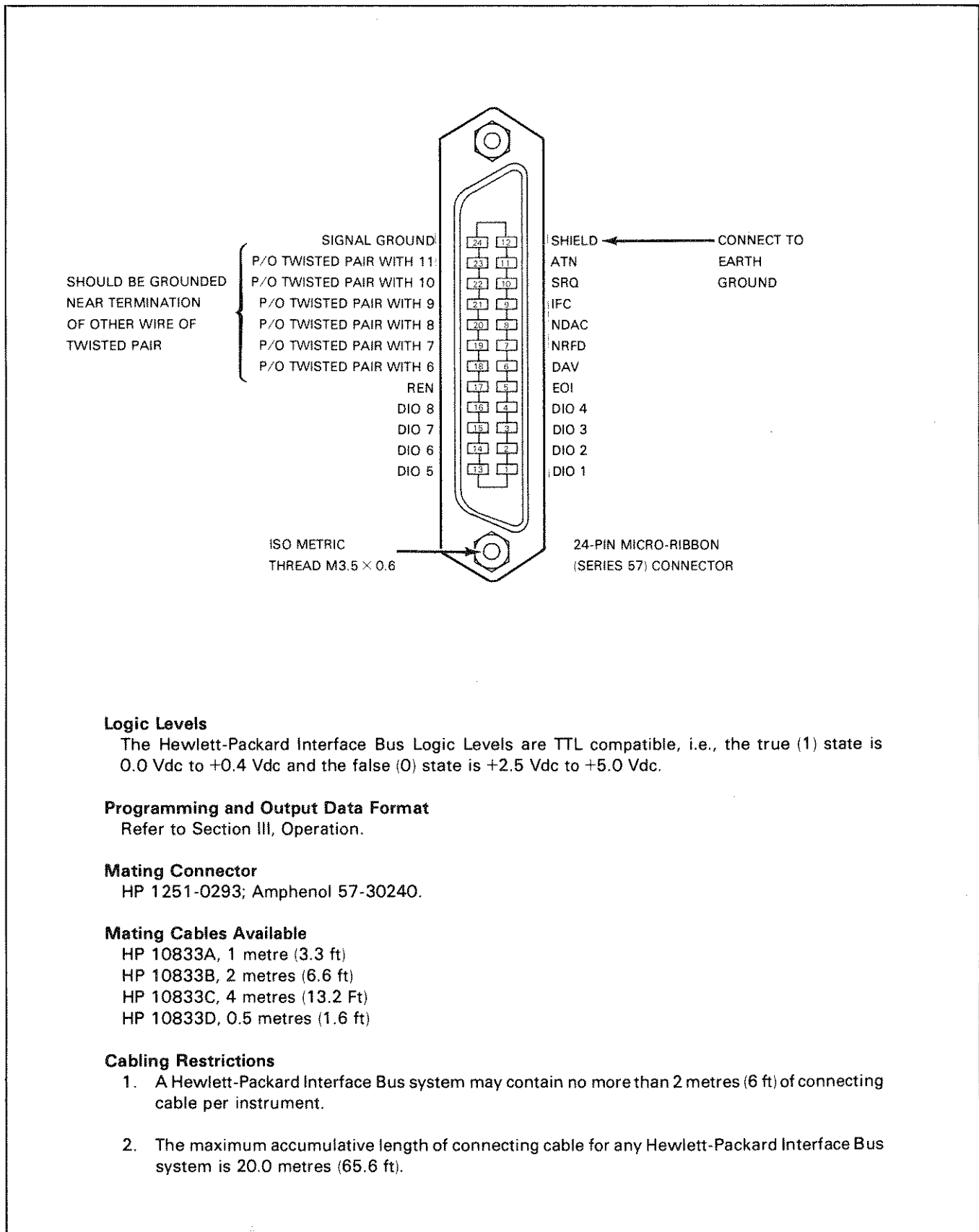

Logic Levels

The Hewlett-Packard Interface Bus Logic Levels are TTL compatible, i.e., the true (1) state is 0.0 Vdc to +0.4 Vdc and the false (0) state is +2.5 Vdc to +5.0 Vdc.

Programming and Output Data Format

Refer to Section III, Operation.

Mating Connector

HP 1251-0293; Amphenol 57-30240.

Mating Cables Available

- HP 10833A, 1 metre (3.3 ft)
- HP 10833B, 2 metres (6.6 ft)
- HP 10833C, 4 metres (13.2 Ft)
- HP 10833D, 0.5 metres (1.6 ft)

Cabling Restrictions

1. A Hewlett-Packard Interface Bus system may contain no more than 2 metres (6 ft) of connecting cable per instrument.
2. The maximum accumulative length of connecting cable for any Hewlett-Packard Interface Bus system is 20.0 metres (65.6 ft).

Figure 2-4. Hewlett-Packard Interface Bus Connection

2-11. Rack Mounting.

Rack mounting information is provided with the rack mounting kits. If a kit was not ordered with the instrument as an option, it can be ordered through the nearest Hewlett-Packard Sales office. Refer to paragraph 1-8, Mechanical Options for the appropriate part numbers.

2-12. STORAGE AND SHIPMENT.

2-13. Environment.

The Measurement System may be stored or shipped in environments within the following limits:

Temperature	-55°C to +75°C
Humidity	< 95% relative
Altitude	< 15 300 metres (50 000 feet)

Protect the instrument from conditions which would cause internal condensation.

2-14. Packaging.

Original Packaging. Containers and materials identical to those used in factory packaging are available through Hewlett-Packard offices. If the instrument is being returned to Hewlett-Packard for servicing, attach a tag indicating the type of service required, return address, model number, and full serial number. Also mark the container FRAGILE to ensure careful handling. In correspondence, refer to the instrument by model number and full serial number.

Other Packaging. The following general instructions should be used for repackaging with commercially available materials:

- a. Wrap instrument in heavy paper or plastic. (If shipping to Hewlett-Packard office or service center, attach tag indicating type of service required, return address, model number, and full serial number.)
- b. Use strong shipping container. A double-wall carton made of 2.4 MPa (350 psi) test material is adequate.
- c. Use a layer of shock-absorbing material 75 to 100 mm (3- to 4-inch) thick around all sides of the instrument to provide firm cushioning and prevent movement inside container. Protect control panel with cardboard.
- d. Seal shipping container securely.
- e. Mark shipping container FRAGILE to ensure careful handling.
- f. In any correspondence, refer to instrument by model number and full serial number.

SECTION III

OPERATION

3-1. INTRODUCTION.

This section contains complete operating information for the 1980A/B Oscilloscope Measurement System. Included in this section are descriptions of all front and rear panel features, local and remote operation, operators checks, adjustments, and maintenance. Also included is a "Getting Acquainted" exercise which is designed to familiarize the first time user with front panel operation and features.

3-2. Operating Characteristics.

The 1980A/B Oscilloscope Measurement System is a two channel, 100 MHz oscilloscope which can be controlled via HP-IB. Complete instrument setups can be programmed and measurement results can be reported under remote control. Eight nonvolatile internal registers can be used for saving and recalling complete instrument setups during local or remote operation. Measurement System capabilities can be extended by adding various internal options and plug-in Expansion Modules.

Table 3-1 summarizes the major operating characteristics of the 1980A/B Oscilloscope Measurement System. For a complete description, refer to Table 1-1, Specifications. HP-IB capabilities are summarized in Table 3-3, Message Reference Table.

3-3. Local Operation.

Instructions for local (i.e., front panel) operation are described in the following paragraphs. To learn the basic operation of the instrument, begin with Simplified Operation and the Getting Acquainted exercise. Once familiar with the general operation, use the Detailed Operating Instructions for complete and in-depth information about operating the Measurement System.

Simplified Operation (page 3-4) is an overview of front panel operation. It provides an introduction to basic operating procedures and front panel controls. An index to the Detailed Operating Instructions is opposite Simplified Operation to guide the operator to further information.

Getting Acquainted (page 3-6) is an exercise for hands-on operation using the major instrument functions. Instrument operating procedures and some basic measurement techniques are explained. The exercise takes about 20 minutes to perform. The only equipment required is a 1980A/B and a probe.

Panel Features (page 3-13) briefly describes all controls, connectors and indicators. Front panel features are discussed in figures 3-5 to 3-9. Rear panel features are in figure 3-10.

Detailed Operating Instructions (page 3-40) provide a complete operating reference for the Measurement System user. They include information about the various measurements that can be made, as well as complete descriptions of all controls and menu functions. The instructions are arranged alphabetically by subject. They are indexed by function in table 3-2.

Each instruction contains a general description that covers signal levels, ranges, measurement limits, and other general information. Following the description, local operating procedures are explained and an example is given to illustrate the procedures. At the end of each instruction, any special considerations are listed that might aid the user. Also included are references to other instructions which contain related information.

3-4. Remote Operation.

Knowledge of local operation is essential for the remote operator to use the full capabilities of the Measurement System. Pages containing explanations of HP-IB related operations are noted with the  symbol. Instructions for HP-IB operation are in the following paragraphs:

Remote Operation, Hewlett-Packard Interface Bus (page 3-18) presents a complete description of the instrument's bus implementation. It covers bus compatibility, HP-IB message response, general Data message (input and output) format rules, and many other basic bus considerations.

Detailed Operating Instructions (page 3-40) explain how to program instrument functions and make bus controlled measurements. Specific format rules and any special programming considerations are described. Each instruction includes a programming example for reference. Table 3-2 indexes the Detailed Operating Instructions by function.

HP-IB Codes and Format Summary (page 3-131) condenses the programming information for the instrument. It is a quick reference for the experienced remote operator. The summary lists all program codes by function and includes a complete description of parameter range and format.

Notation Conventions and Definitions (page 3-137) explains the syntax conventions used in the manual.

3-5. Operator's Checks.

This section includes procedures that allow the operator to make a quick evaluation of instrument operation. The following checks are provided:

Confidence Test (page 3-32) is a menu function that assures most of the instrument is operating properly. This procedure only requires a probe or BNC cable.

Memory Check (page 3-33) is a menu function that verifies the content and operation of ROM and RAM memory. No additional equipment is required.

HP-IB I/O Check (page 3-33) confirms that the Measurement System responds properly to all HP-IB messages. This check assumes that local operation has been verified with the Confidence Test and Memory Check procedures. An HP-IB controller, interface and connecting cable are required.

3-6. Operator's Calibration and Adjustment.

This section provides several procedures that should be used periodically to ensure measurement accuracy. Each procedure includes a brief description of the adjustment and the recommended calibration cycle. The following procedures are provided:

Delay Time Self-cal (page 3-38) is a menu function that automatically nulls drift in the delay circuits. The Delay Self-cal routine should be executed before all critical measurements where the highest resolution and accuracy are required.

Vertical Balance Self-cal (page 3-39) is a menu function that nulls the offsets within the vertical amplifiers. Execute this routine if trace baselines shift as vertical deflection factor is changed.

CRT Display Adjustment (page 3-40) explains how to set trace alignment, focus, and astigmatism.

Probe Compensation (page 3-40) describes how to adjust the low frequency compensation of probes used with the Measurement System.

3-7. OPERATOR'S MAINTENANCE.

The only instrument maintenance an operator needs to perform is to occasionally clean the CRT contrast filter and the instrument front panels using a soft cloth and either a commercial glass cleaner, or a mild soap and water solution.

**WARNING**

Do not remove covers. Internal parts present an electrical shock hazard. Refer servicing to qualified service personnel.

**CAUTION**

Do not use chemical cleaning agents or abrasive cleaners that might damage the plastics in this instrument. Recommended cleaning agents are isopropyl alcohol, kelite (1 part kelite, 20 parts water), or a solution of 1% mild detergent and 99% water.

3-8. GENERAL OPERATING INSTRUCTIONS.

WARNING

Before switching the instrument on, connect all protective earth terminals, extension cords, auto-transformers, and devices to a protective earth grounded socket. Any interruption of protective earth grounding is a potential shock hazard that could result in personal injury or death.

Only use 250V fast blow fuses with the required current rating. Do not use repaired fuses or short circuited fuseholders. To do so could cause severe shock or fire hazard.

CAUTION

Before switching the instrument on, it must be set to the voltage of the power source, or damage to the instrument may result.

Do not operate the instrument with its enhancement slot uncovered. If there is no plug-in installed, the plug-in filler must be in place. Otherwise, damage to the instrument could result.

A stationary, high intensity spot (trace intensity level > 25) can cause CRT damage.

Excessive input voltage will damage the input attenuators and amplifiers. Observe the maximum input rating described in Table 1-1, Specifications.

Switch off instrument power before installing or removing a plug-in Expansion Module. Otherwise, damage to the instrument or plug-in could result.

3-9. Power-on.

Power-on Procedure. Before turning the instrument on the first time, follow these instructions.

On the rear panel:

1. Check line voltage switches for correct voltage selection.
2. Check fuse for correct current rating. Current ratings are printed on the line module.
3. Plug in power cable.

Then set the front-panel LINE switch to ON.

Power-on Configuration. The Measurement System turns on with the same settings it had before it was switched off (that is, if line power was removed). The exceptions to this rule are described in the "Power-on Sequence and Default Conditions" Detailed Operating Instruction. The primary default conditions are:

- * Any DC 50 ohm vertical or trigger couplings are changed to DC.
- * Menus are turned off.
- * Advisory messages are enabled.
- * All HP-IB conditions default except address and addressing mode selection.

Table 3-1. Operating Characteristics

Operating Parameter	Capability	Operating Parameter	Capability
Autoscope	Autoscope autoranges trigger level, deflection factor, and sweep speed for repetitive input signals > 20 mV p-p and > 50 Hz.	Implemented HP-IB Subsets	As defined in IEEE Std 488: SH1, AH1, T5, TE0, L3, LE0, SR1, RL1, PPO, DCO, DT1, CO, and E2.
Calibrator Output	Frequency: 1.86 kHz Level: 1 V p-p, normal mode 20 mV p-p, 100 mV p-p, 200 mV p-p, and 10 V p-p can be programmed via HP-IB.	Maximum Input Voltage (channel 1, 2, and external trigger inputs) DC 50 ohm-coupled DC or AC-coupled	Level: 5 Vrms Level: 250 V (dc+peak ac) at ≤ 1 kHz
Delay Time	Range: 0.0 nsec to 9.999 sec		
Digital Delay	Range: 0 to 99 999 999 trigger events		
Delta Time	Range: (0-Tzero) sec to (9.999-Tzero) sec		
Delta Volts (channel 1 and 2)	Range: ±15 times channel deflection factor		
Horizontal Position	Range: ± 6 major divisions		
Dual Separation	Range: ± 5 major divisions		
Sweep Speed (main and delayed)	Range: 5 nsec/div to 1 sec/div		
Trigger Level (main and delayed) internal source external source	Range: ±20 major divisions Range: ±1, ±1.2 V ±10, ±12 V		
Vertical Deflection (channel 1 and 2)	Range: 2 mV/div to 10 V/div		
Vertical Position (channel 1 and 2)	Range: ± 15 major divisions		

Maximum Input Voltage at Frequencies ≥ 1 kHz

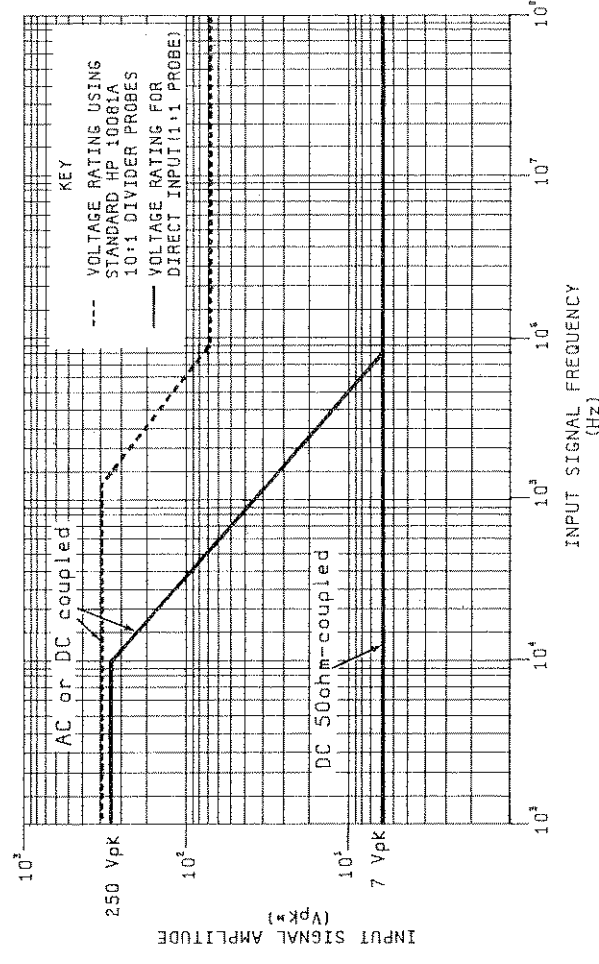

*Vpk RATING BASED UPON CONTINUOUS SINE WAVE INPUT

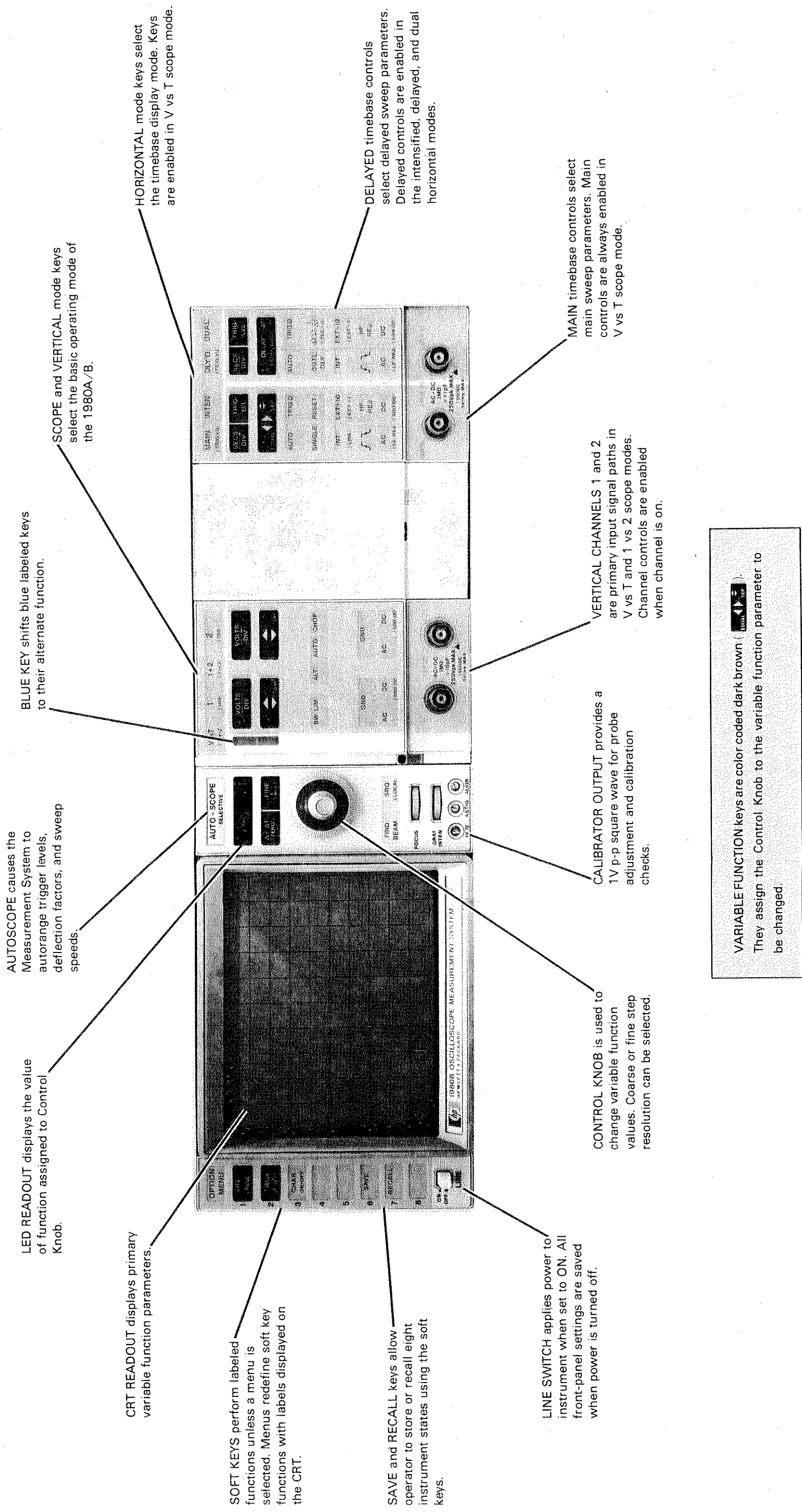

Figure 3-1. Front Panel Features

SIMPLIFIED OPERATION

Obtaining a Basic Display

Use autoscope to quickly set up the 1980A/B for a basic, triggered display. Connect the signal to be viewed to channel 1 or 2, and press **AUTO-SCOPE SELECTIVE**.

Indications

Active functions or operating modes are indicated by the lighted keys and the CRT readout.











Primary variable function values are displayed in the CRT readout for convenient reference.

Advisory messages are displayed on the CRT as an operator's aid. They are displayed momentarily when an illegal key entry is made or when other conditions occur that may require additional information.

Changing Values

Variable function values can be changed with the Control Knob.

Assign the Control Knob to a variable function by pressing the corresponding variable function key:

	trace intensity
	panel intensity
	character intensity
 (ch 1 or 2)	deflection factor
 (ch 1 or 2)	vertical position
 (main or dly'd)	sweep speed
 (main or dly'd)	trigger level
	horizontal position
	dual separation
	delay
	delay, numerical entry mode

Then increment or decrement the function value by rotating the Control Knob.

The Control Knob is a stepping control. Coarse or fine step resolution can be selected with **FINE**.

Soft Key Menus

The function of the soft keys is changed when a menu is called to the CRT. Menus redefine the soft keys with displayed labels such as:



The menus can be turned on and off by pressing **OPTION MENU**.

Table 3-2. Detailed Operating Instructions Index

Instruction	Page	Instruction	Page
Display Functions			
Advisory Messages	3-42	Horizontal Mode	3-66
Character Generator	3-52	Initialize	3-73
Horizontal Mode	3-66	Scope Mode	3-88
Horizontal Position	3-68	Vertical Mode	3-127
HP-IB Status Advisory	3-70	Special Functions	
Intensity, Characters and Lamps	3-77	Autoscope	3-46
Intensity, Trace	3-78	Calibrator Level	3-50
Scope Mode	3-88	Character Generator	3-52
Separation, Dual	3-90	Control Knob	3-54
Text Display	3-104	Delta Time	3-60
Trigger View	3-120	Delta Volts	3-62
Vertical Mode	3-127	Initialize	3-73
Errors and Advisories			
Advisory Messages	3-42	Key	3-79
Error Messages	3-64	Save/Recall	3-86
HP-IB Status Advisory	3-70	Soft Key Menus	3-93
HP-IB Syntax Errors	3-72	Text Display	3-104
Instrument Status	3-75	Trigger Flag	3-117
Power-on Sequence and Default Conditions	3-83	Trigger Functions	
Service Request Condition	3-91	Delay	3-57
Horizontal Functions			
Control Knob	3-54	Sweep Mode, Delayed	3-96
Delay	3-57	Sweep Mode, Main	3-98
Delta Time	3-60	Trigger, Delayed Sweep	3-107
Horizontal Mode	3-66	Trigger, Main Sweep	3-112
Horizontal Position	3-68	Trigger Flag	3-117
Sweep Mode, Delayed	3-96	Trigger View	3-120
Sweep Mode, Main	3-98	Vertical Coupling	3-122
Sweep Speed, Delayed	3-100	Vertical Deflection Factor	3-125
Sweep Speed, Main	3-102	Variable Functions	
Trigger, Delayed Sweep	3-107	Control Knob	3-54
Trigger, Main Sweep	3-112	Delay	3-57
Trigger Flag	3-117	Delta Time	3-60
Trigger View	3-120	Delta Volts	3-62
HP-IB Functions			
Calibrator Level	3-50	Horizontal Position	3-68
Control Knob	3-54	Intensity, Characters and Lamps	3-77
HP-IB Address	3-69	Intensity, Trace	3-78
HP-IB Status Advisory	3-70	Reading Values Via HP-IB	3-84
HP-IB Syntax Errors	3-72	Separation, Dual	3-90
Instrument Status	3-75	Sweep Speed, Delayed	3-100
Key	3-79	Sweep Speed, Main	3-102
Learn Mode	3-82	Trigger, Delayed Sweep	3-107
Reading Values Via HP-IB	3-84	Trigger, Main Sweep	3-112
Service Request Condition	3-91	Vertical Deflection Factor	3-125
Text Display	3-104	Vertical Position	3-129
Trigger Flag	3-117	Vertical Functions	
Scope Functions			
Autoscope	3-46	Bandwidth Limit	3-49
		Control Knob	3-54
		Delta Volts	3-62
		Vertical Coupling	3-122
		Vertical Deflection Factor	3-125
		Vertical Mode	3-127
		Vertical Position	3-129

GETTING ACQUAINTED EXERCISE

3-10. GETTING ACQUAINTED EXERCISE.

This exercise is designed to acquaint you with front-panel operation of the Measurement System. It provides a demonstration of general operating features and many of the special functions. In addition, some basic measurement techniques are described. The exercise should take about 20 minutes to perform. The only equipment required is a 1980A/B and a probe.

CAUTION

Before turning the instrument on the first time, follow these instructions.

On the rear panel:

- 1. Check line voltage switches for correct voltage selection.*
- 2. Check fuse for correct current rating. Current ratings are printed on the line module.*
- 3. Connect power cable.*

Set the front-panel LINE switch to ON.

Set up the 1980A/B by connecting the calibrator signal to the channel 2 input (figure 3-2).

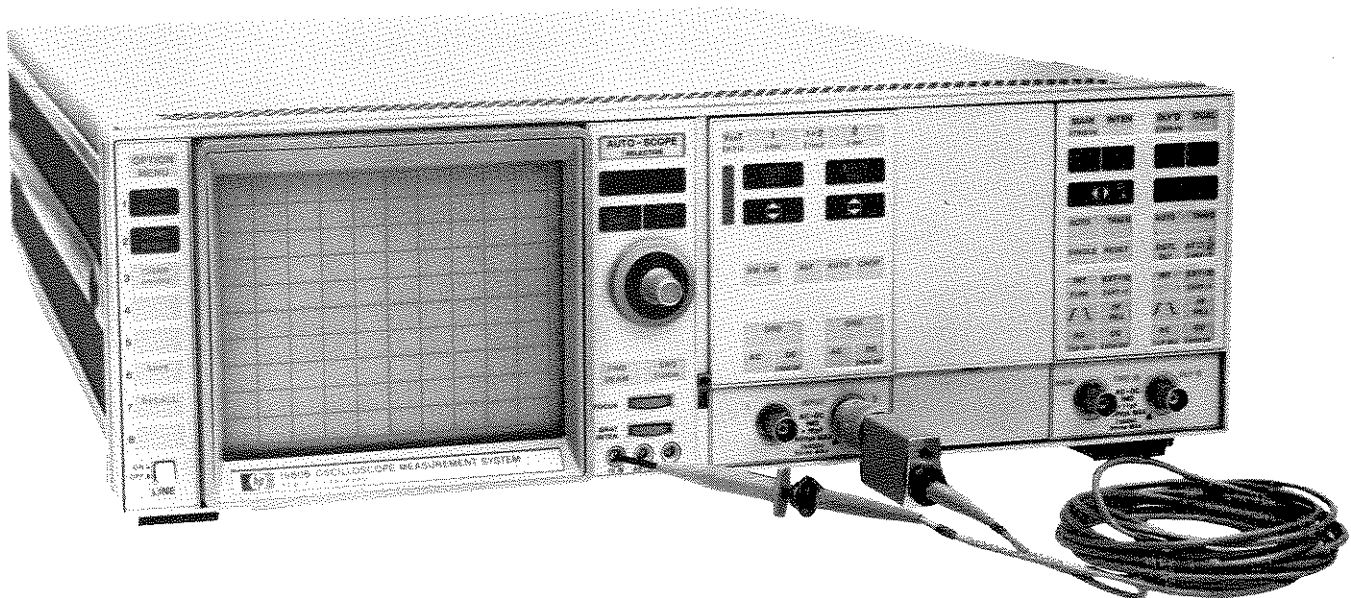

80-348

Figure 3-2. Getting Acquainted Exercise Setup

GETTING ACQUAINTED EXERCISE

INITIALIZE
Set LINE switch to OFF, then to ON.

3-11. Using Autoscope.

Autoscope is a convenient means of obtaining a basic display of an unknown signal. In executing autoscope, the 1980A/B scans the vertical inputs, selects trigger sources, and autoranges trigger levels, deflection factors and sweep speeds.

Execute autoscope, press .







After autoscope, the 1980A/B displays input signals plotted vs main sweep. Main sweep speed is selected to display ~2 cycles of the waveform. If only one signal is applied, deflection factor is selected so the displayed signal is ~3 divisions peak to peak.

For more information about the autoscope function, refer to the "Autoscope" Detailed Operating Instruction.

3-12. Keys and Indications.

Instead of conventional mechanical switches, the 1980A/B has membrane switch keys to control instrument operation. Instrument setup is stored in nonvolatile memory, so it is not lost when instrument power is cycled off and on. The keys are easy to operate, just press on the center of the key legend.

Active functions or operating modes are indicated by lighted keys. For example, press  to turn on vertical bandwidth limit. The key lights to indicate bandwidth limit is on.

 is used to select blue-labeled shift functions.  shifts only the next key that is pressed. If the next key has no blue shift function, the normal function is performed. For example, to invert channel 2, first press . It lights to indicate that a blue function can be selected. Now press  to select inverted display. Invert is a toggling function, so press  to restore noninverted display. Press . Because  has no blue function, the shift is ignored.

Advisory messages provide supplemental operating information. They are displayed momentarily on the CRT when invalid operations are attempted or when certain special conditions are in effect. For an example, press . The advisory **KEY DISABLED** is displayed to indicate the key has no function in the current operating mode. A description of all advisory messages (and suggested response) is contained in the "Advisory Messages" Detailed Operating Instruction.

Primary variable function parameters are displayed in the CRT readout. Figure 3-3 describes the readout display when channel 1 and 2, and both main and delayed timebases are on.

3-13. Changing Values.

Parameter values of variable functions are changed with the Control Knob. The Control Knob is a digital control with an "analog feel". Values set by the knob are stored in nonvolatile memory, so they are not lost when instrument power is cycled off and on.

GETTING ACQUAINTED EXERCISE

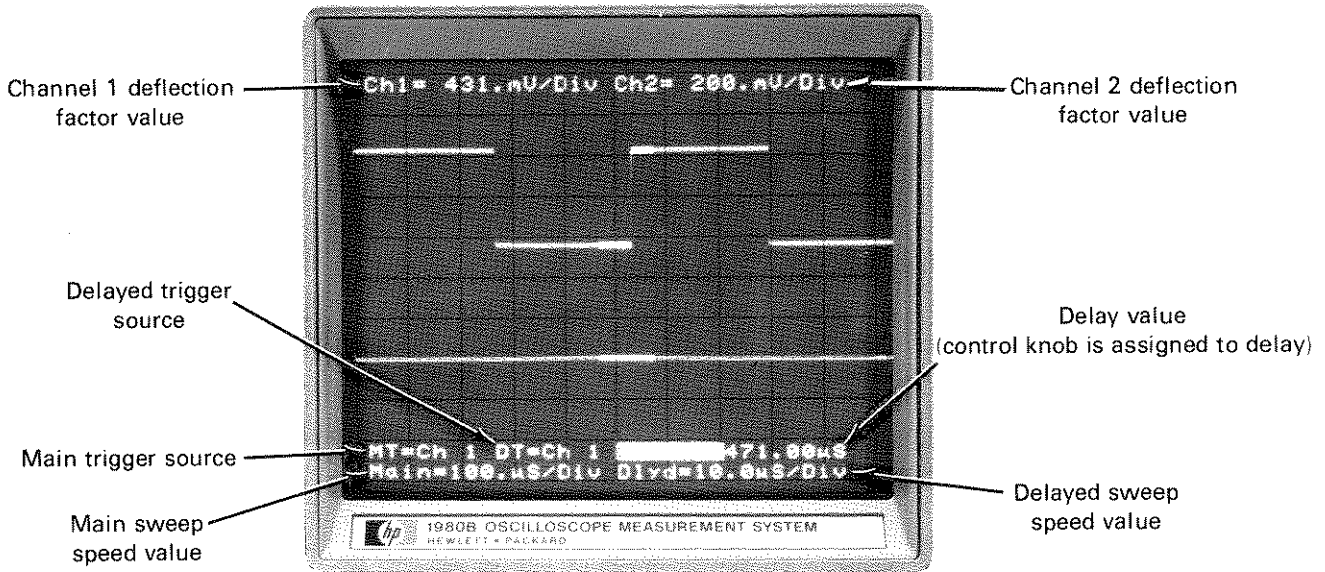

Figure 3-3. The CRT Readout

80-344

Executing autoscope assigns the Control Knob to main sweep speed. To indicate this selection, **SECB DIV** (main) is lighted and the LED readout displays the main sweep speed value. Also, the CRT readout displays **MAIN** in inverse video to indicate that the Control Knob is assigned to main sweep speed.

Change the main sweep speed by rotating the Control Knob. Press **FINE HOLD** to toggle between fine and coarse step resolution. When coarse is selected, sweep speed changes in relatively large steps. In contrast, fine provides a vernier-like adjustment that is continuously in calibration.

Now, change the deflection factor value for channel 2. Press **VOLTS DIV** (ch 2) to assign the Control Knob. Notice the change in the CRT and LED readouts. Change the deflection factor by rotating the Control Knob. Again, try making both fine and coarse adjustments.

Accidental changes to values can be prevented by putting the Control Knob in hold mode. To select hold, press **FINE HOLD**. To exit hold mode, press any enabled variable function key.

For more information about using the Control Knob, refer to the "Control Knob" Detailed Operating Instruction.





3-14. Using the Trigger Controls.

With the 1980A/B, stable triggering is easy to establish using this general procedure:



Check that both the main and delayed sweeps are in auto sweep mode. **AUTO SW** and **AUTO SWEEP-A** should both be lighted.



Select the signal source for the main sweep trigger. Since the calibrator signal is connected to channel 2, press **INT**. When **2** is pressed, the advisory **TO CHANGE INT SRC (SEL CHAN)** is displayed. This is just a reminder to

GETTING ACQUAINTED EXERCISE

press either  or  to specify the source. Otherwise, the last internal trigger source is restored. The CRT readout displays the selected trigger source.

Press  (main) and adjust main trigger level with the Control Knob for a triggered display. As an adjustment aid, the trigger signal is displayed while the Control Knob is turned. The center horizontal graticule line represents the trigger threshold level with respect to the trigger signal.

When adjusting trigger controls, begin with the timebases in auto-sweep mode so there is a trace displayed. For example, press  (dly'd) to put delayed sweep in triggered mode. Because channel 1 is selected as the delayed trigger source and the trigger level is misadjusted, delayed sweep is not triggered. This inhibits main sweep and trigger view making it more difficult to correct the triggering problem. Notice that the delayed sweep NOT indicator is lighted. The NOT indicators show which sweep is not triggered. Press  to return delayed to auto-sweep mode.

Now select the trigger source and level for delayed sweep. Press    (dly'd) and rotate the Control Knob until trigger signal overlaps the center horizontal graticule line.

In some cases, it is desirable to display the trigger signal continuously. Press  to display main trigger view.

The trigger circuits are both level and edge sensitive. Press  (main) to toggle the main trigger point between positive and negative slope.

For more information about triggering, refer to the "Trigger, Delayed Sweep", "Trigger, Main Sweep" and "Trigger View" Detailed Operating Instructions.

INITIALIZE



Press: 

3-15. Using Delayed Sweep.

This procedure describes some basic features of delayed sweep operation. Press  to display delayed sweep as a marker on the main sweep.

When the delayed sweep is in auto mode, marker position is determined solely by the delay time value. Press  and change delay time with the Control Knob until the marker overlaps the falling edge of the first pulse.

Press  to display the delayed sweep. This provides an expanded view of the pulse edge.

Select dual horizontal mode, press . Dual displays both the main and delayed sweep traces. The main sweep marker indicates the portion of the waveform displayed in delayed sweep. Press  (ch 2) and center the main sweep trace in the upper half of the CRT using the Control Knob. Press  and use the Control Knob to change the separation between sweeps for convenient viewing.

Press  (dly'd) and change the delayed sweep speed with the Control Knob. Try using both coarse and fine. Because the sweep rates of the two timebases are independent of each other, delayed sweep can actually be slower than main sweep.

GETTING ACQUAINTED EXERCISE

Delayed sweep can start after main sweep is completed. Press  and rotate the Control Knob until the marker goes off screen. The advisory `INTEN'D TRACE OFF SCREEN` is displayed as a reminder that delay time value is longer than main sweep.

To zero the delay value, press .

For more information about delayed sweep, refer to the "Sweep Mode, Delayed" and "Sweep Speed, Delayed" Detailed Operating Instructions.

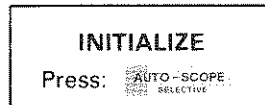

3-16. Using Delta Volts.

Voltage measurements are simplified with the ΔV function. Try this procedure for peak to peak measurements:

Position channel 2 so the bottom peak of the waveform is on the center horizontal graticule line. Press  (ch 2) and position with the Control Knob.

Press  to turn on and zero the ΔV function.

Now make the voltage measurement. Change channel 2 position with the Control Knob until the top peak is on the center horizontal graticule line.

Read the peak to peak voltage (expressed as ΔV) in either the LED or CRT readout.

For more information about voltage measurements, refer to the "Delta Volts" Detailed Operating Instruction.

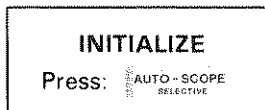



3-17. Using Delta Time.

Timing or frequency measurements can be made quickly with the 1980A/B by using the ΔT function. Try this basic procedure for measuring pulse risetime:

Change channel 2 deflection factor so that the input signal is displayed as 5 divisions peak to peak, press  (ch 2) and adjust with Control Knob.

Change channel 2 vertical position, if necessary, to center waveform. Waveform peaks should just reach the 0 and 100% points marked on the right hand side of the CRT. Press  (ch 2) and center with Control Knob.

Press  to display delayed sweep as a marker on waveform.

Change delay time until marker starts at the beginning of the rising edge of the second pulse. Press  and move marker with the Control Knob.

GETTING ACQUAINTED EXERCISE

Decrease marker width by increasing delayed sweep speed until marker just overlaps the pulse rising edge. Press **SECS** (dly'd) and adjust with the Control Knob.

Display the delayed sweep trace only, press **DLY'D**.

Change delay time until pulse edge intersects the center vertical graticule line at the 10% point. Press **DELAY** and change with the Control Knob.

Press **AVT** to turn on and zero the ΔT function.

Increase delay time with the Control Knob until the pulse edge intersects the center vertical graticule line at the 90% point.

Read the pulse risetime (expressed as ΔT) in either the LED or CRT readout.

For more information about timing measurements, refer to the "Delta Time" Detailed Operating Instruction.

INITIALIZE
Set LINE switch to OFF, then to ON.

3-18. Using Soft Key Menus.

Soft key menus add many special measurement and utility functions to the instrument. Menus redefine the soft keys with labels displayed on the CRT. To call the first level menu, press **OPTION MENU**. Figure 3-4 contains an explanation of the soft key functions defined by **OPTION MENU**.

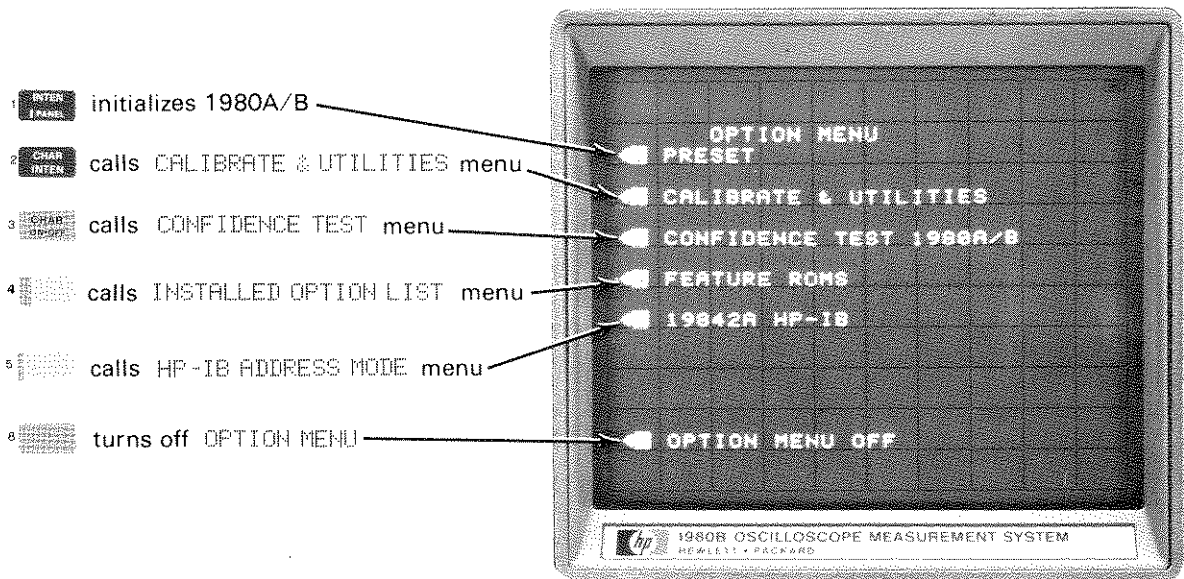

Figure 3-4. The **OPTION MENU** Soft Key Definitions

80-345

Press **CHAR** **CONFIDENCE TEST 1980A/B**. This calls **CONFIDENCE TEST** menu which contains instructions for the test.
Press **SRG** to test channel 2.

GETTING ACQUAINTED EXERCISE

Confidence Test executes a series of autoscopes while changing the calibrator output level. It checks the vertical attenuators, and the vertical, horizontal, and trigger circuits. At the end of the test, an advisory is displayed to indicate whether the instrument passed or failed.

Now, call the UTILITIES menu by pressing:

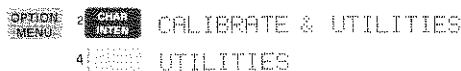

Utility functions are primarily used for testing and servicing the instrument.

All menus (except OPTION MENU) provide backstep capability to allow returning to the previous menu. Return to the CALIBRATE & UTILITIES menu by pressing the PREVIOUS MENU key.

To return the soft keys to their normal functions, press the OPTION MENU key.

For more information about menu functions, refer to the "Soft Key Menus" Detailed Operating Instruction.

INITIALIZE
Set LINE switch to OFF, then to ON.

3-19. Using Save/Recall.

When a test sequence is used repetitively, instrument states can be stored in the Save/Recall registers for recall during the procedure. Up to eight instrument states can be stored. The registers are selected using the soft keys after the SAVE SETTINGS AT [S] menu is called.

Store the current instrument state in register S1, press the SAVE key (top left) and the INTEN [PARAM] key (top right) S1.

Change the instrument state, press the OPTION MENU key (top left) and the INTEN [PARAM] key (top right) PRESET.

Store this state in S2, press the SAVE key (top left) and the CHAR INTEN key (top right) S2.

Recall S1, press the RECALL key (top left) and the INTEN [PARAM] key (top right) S1.

Recall S2, press the RECALL key (top left) and the CHAR INTEN key (top right) S2.

Refer to the "Save/Recall" Detailed Operating Instruction for more information.

3-20. PANEL FEATURES.

Soft Keys

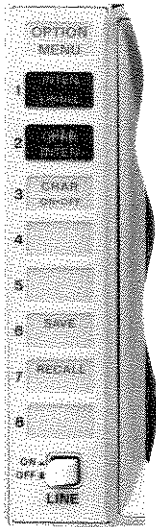

- 1. **OPTION MENU** calls **OPTION MENU** which redefines the soft key functions with labels displayed on the CRT. When a menu is displayed, pressing **OPTION MENU** returns the soft keys to their normal functions.
- 1. **INTEN (PANEL)** assigns the Control Knob to trace intensity.
- 2. **INTEN (PANEL)** assigns the Control Knob to panel intensity.
- 2. **CHAR (INTEN)** assigns the Control Knob to character generator intensity.
- 3. **CHAR (ON-OFF)** toggles character generator on and off.
- 4. (blank) has no function except as defined by menus.
- 5. (blank) has no function except as defined by menus.
- 6. **SAVE** calls the **SAVE SETTINGS AT SC1** menu. The soft keys are then defined to store instrument state in the corresponding Save/Recall register. **OPTION MENU** turns off the **SAVE SETTINGS AT SC1** menu.
- 7. **RECALL** calls the **RECALL SETTINGS AT SC1** menu. The soft keys are then defined to recall the instrument state stored in the corresponding Save/Recall register. **OPTION MENU** turns off the **RECALL SETTINGS AT SC1** menu.
- 8. (blank) has no function except as defined by menus.

Figure 3-5. Display Panel Features

80-82

Channel 1 and 2 deflection factor is displayed if the channel is on or is selected as a trigger source. If ΔV mode is selected, Δ value is displayed instead of deflection factor.

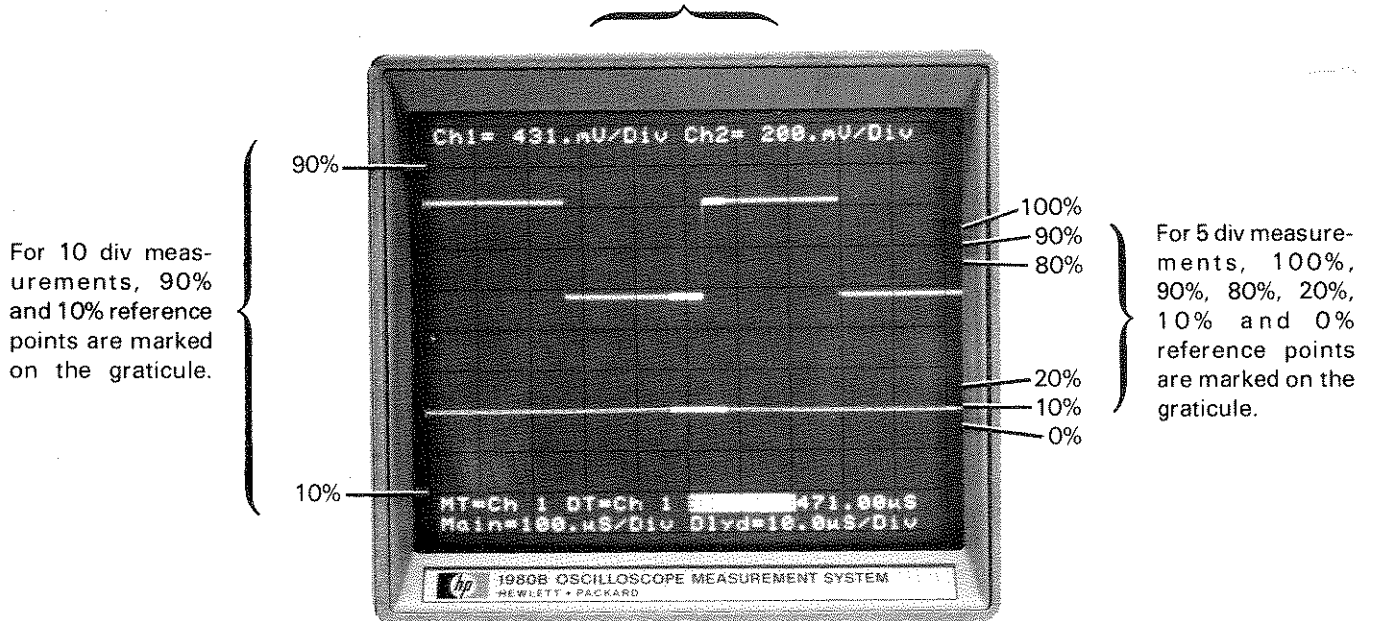

For 10 div measurements, 90% and 10% reference points are marked on the graticule.

For 5 div measurements, 100%, 90%, 80%, 20%, 10% and 0% reference points are marked on the graticule.

80-344

Main and delayed sweep speed, trigger source, and delay values are displayed if the timebase is on. If ΔT mode is selected, ΔT value is displayed instead of the delay value.





Figure 3-6. CRT Features

Autoscope

 executes autoscope.

 executes selective autoscope. Instrument autoranges deflection factor and sweep speed but preserves channel selection, coupling and trigger setups.

Delta Time and Delta Volts

 selects ΔT mode if the Control Knob is assigned to delay (). If Control Knob is assigned to vertical position ( ch 1 or 2),  selects ΔV mode for the corresponding channel. If the Control Knob is assigned to a Δ function, pressing  turns off that mode and restores normal delay time or vertical position control.

Control Knob



is used to change variable function parameter values. It is assigned to a function by pressing the corresponding variable function key. The function value is displayed in the LED readout.

 toggles the Control Knob step resolution between fine and coarse.

 puts the Control Knob in hold.

Beam Finder

 changes the gain of the vertical and horizontal output amplifiers so that when the beam is off screen, it can be located.

Service Request

 is used in remote operation to request service from the HP-IB controller.

Return to Local

 switches the 1980A/B from remote to local mode unless local lockout is in effect.

CRT Adjustments

- FOCUS adjusts spot size for sharp display.
- GRAT INTEN illuminates the CRT graticule for photographing.
- ASTIG adjusts spot shape for sharp display.
- ALIGN adjusts the horizontal alignment of the sweeps with the CRT graticule.

Figure 3-7. Control Panel Features

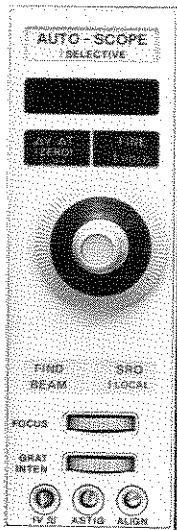

80-81

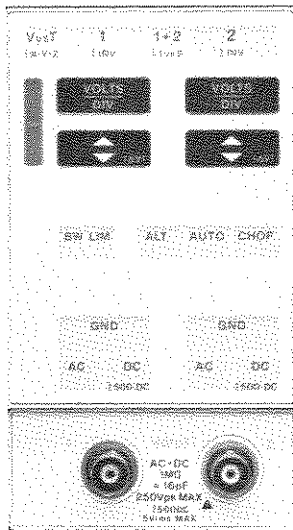

80-81

Scope Mode

- selects normal oscilloscope mode, input signals (Y-axis) plotted vs timebase signals (X-axis).
- selects X-Y mode, channel 1 signal (Y-axis) plotted vs channel 2 signal (X-axis). Timebases are disabled.
- selects display mode using rear-panel X, Y, and Z-blanking inputs. Disables channels 1 and 2, and timebases.

Blue Key

shifts blue labeled keys to their alternate function. applies only to the next key that is pressed. If the next key has no blue labeled function, the shift is ignored.

Vertical Mode

- and toggle corresponding channels on and off.
- turns on channel 1 and 2, displays algebraic sum. Can be used for differential measurements when one channel is inverted with respect to the other.
- selects alternate or chop mode automatically.
- and provide manual selection of alternate or chop mode.

Vertical Deflection Factor

- (ch 1 or 2) assigns Control Knob to vertical deflection factor.
- inverts channel 1.
- inverts channel 2.

Vertical Position

(ch 1 or 2) assigns Control Knob to vertical position.

Vertical Coupling

, , , and (ch 1 or 2) select the input signal coupling.

Bandwidth Limit

toggles bandwidth limit on or off. Can be used in V vs T or 1 vs 2 modes to limit vertical response.

Channel Inputs

Channel 1 and 2 inputs are female BNC connectors which have the special probe key contact. When the recommended HP probes are connected, channel deflection factor is displayed as the total value at the probe tip.

Figure 3-8. Voltage Panel Features

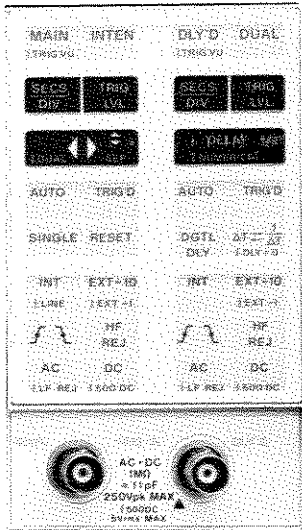

80-80

Horizontal Mode

- MAIN** enables and displays main timebase only.
- INTEN** enables main and delayed timebases. Displays delayed sweep as a marker on main sweep trace.
- DLY'D** enables main and delayed timebases. Displays delayed sweep only.
- DUAL** enables main and delayed timebases. Displays main and delayed sweeps in alternate or chop, depending on vertical display mode selection.

Trigger View

- MAIN** toggles the main trigger view on or off.
- DLY'D** toggles delayed trigger view on or off.

Horizontal Position

- HOR** assigns Control Knob to horizontal position.

Dual Separation

- DUAL** assigns Control Knob to dual separation.

Sweep Mode

- AUTO**, **TRIG'D**, and **SINGLE** select the mode of main sweep operation.
- AUTO**, **TRIG'D**, and **DLY'D** select the mode of delayed sweep operation.
- RESET** resets both main and delayed sweeps.

Sweep Speed

- SECS DIV** (main or dly'd) assigns the Control Knob to sweep speed.

Delay

- DEL** assigns the Control Knob to delay, normal entry mode. If delayed sweep is in auto-sweep or triggered sweep modes, delay value is in units of time. In digital delay mode, delay is expressed as trigger events.
- DEL** assigns the Control Knob to numerical time entry mode if delayed sweep is in auto-sweep or triggered sweep modes.

Trigger

- TRIG LVL** (main or dly'd) assigns the Control Knob to trigger level.
- INT** and **INT** select internal trigger source for main and delayed. Specify desired vertical channel by pressing **1** or **2**.
- EXT-10** (main or dly'd) selects external ÷ 10 trigger source.
- EXT-1** (main or dly'd) selects external ÷ 1 trigger source.
- LINE** selects line trigger source for main sweep.
- TRIG** (main or dly'd) toggles trigger slope between positive and negative edge.
- HP** (main or dly'd) selects low pass filter on trigger signal.
- AC** (main or dly'd) selects high pass filter on trigger signal. Cannot be used in DC coupling.
- AC**, **DC**, and **DC** (main or dly'd) select the coupling for external trigger inputs.

External Trigger Inputs

Main and delayed inputs are female BNC connectors which have the special probe key contact. When the recommended HP probes are connected, external trigger level is displayed as the total value at the probe tip.

Figure 3-9. Time Panel Features

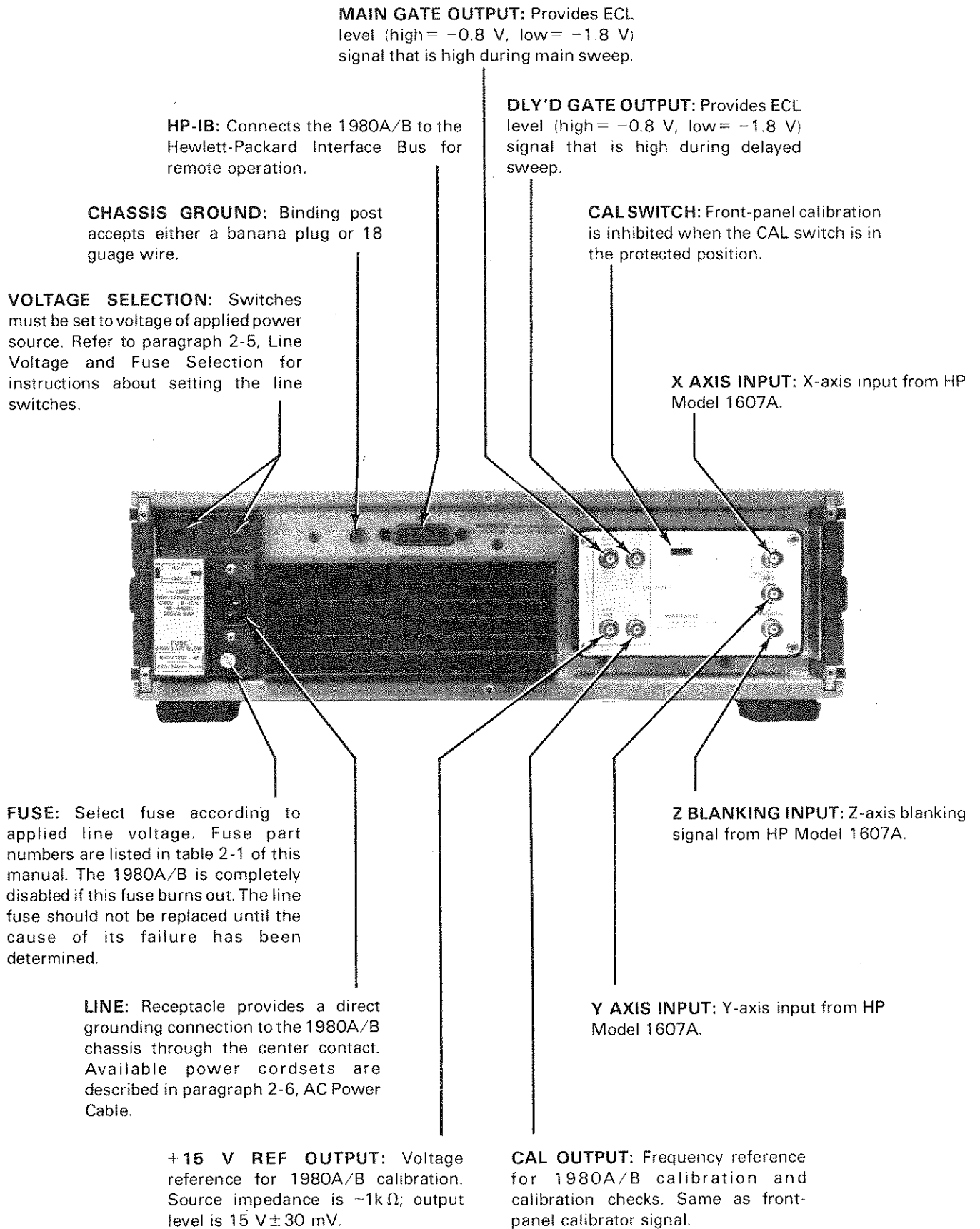



Figure 3-10. Rear-panel Features



3-21. REMOTE OPERATION, HEWLETT-PACKARD INTERFACE BUS.

The 1980A/B Oscilloscope Measurement System can be operated through the Hewlett-Packard Interface Bus (HP-IB). Menu functions, remote only functions, and all front panel functions (except those of , LINE switch, and the CRT display adjustments) are programmable through the HP-IB. Bus compatibility, programming, and data format are described in the following paragraphs.

The notation used in this section to describe bus communications is defined in paragraph 3-56, Notation Conventions and Definitions.

In this manual, the 1980A/B program codes are listed in ASCII code. Table 3-30, Commonly Used Code Conversions, includes a listing of ASCII characters and some commonly used equivalent codes.

A quick check of the instrument HP-IB functions is provided in the HP-IB I/O Check (paragraph 3-47). It verifies that the instrument can respond to or send each of the applicable HP-IB messages described in table 3-3.

For more information about HP-IB, refer to IEEE Std 488 (or the identical ANSI Standard MC1.1), "IEEE Standard Digital Interface for Programmable Instrumentation". The Hewlett-Packard catalog and the booklet "Improving Measurements in Engineering and Manufacturing" (HP part number 5952-0058) provide an overview of bus operation and useful information about HP-IB system applications.

3-22. HP-IB Compatibility.

The Measurement System's complete bus compatibility as defined in IEEE Std 488 is presented in table 3-3.

The programming capability of the instrument is further described by the twelve HP-IB meta messages in the left hand column of table 3-3. Foremost among these is the Data message. Data messages contain the program codes that set the instrument's mode of operation.

Table 3-3. HP-IB Message Reference Table (1 of 2)



HP-IB Meta Message	Applicable	Instrument Response	Related Commands and Control Lines	Interface Functions
Data	Yes	All front panel, menu, and remote functions are bus programmable except LINE switch,  , and CRT adjustments. Also, all instrument settings may be read via the HP-IB.	DAB EOI EOS	MLA UNL MTA UNT OTA L3 T5
Trigger	Yes	Does not have device trigger capability, however, GET is decoded and available for use by internal or plug-in options.	GET MLA	DT1
Clear	No	Does not respond to the Clear message.	DCL SDC	DC0

Table 3-3. HP-IB Message Reference Table (2 of 2)



HP-IB Meta Message	Applicable	Instrument Response	Related Commands and Control Lines	Interface Functions
Remote	Yes	Enabled to remote mode when the REN bus control line is true. However, it remains in local until it is addressed to listen the first time. Control Knob is put in hold on local to remote transition.	REN MLA	RL1
Local	Yes	Returns from remote to local when it receives the Local message or the key sequence  is pressed. Settings remain unchanged after the remote-to-local transition.	GTL MLA	RL1
Local	Yes	When in remote, and local lockout is in effect, the front panel is disabled. Only the system controller can return the instrument to local.	LL0	RL1
Clear Lockout/ Set Local	Yes	Returns to local and local lockout is cleared when the REN bus control line goes false.	REN	RL1
Pass/Take Control	No	The controller subset is not implemented.	TCT	CO
Require Service	Yes	Sets the SRQ line true when one of the service request conditions occur, if it has been enabled to send the RQS message for that condition.	SRQ	SR1
Status Byte	Yes	Responds to a Serial Poll Enable (SPE) bus command by sending an eight-bit byte when it is addressed to talk. Bit 7 (RQS bit) is true if the 1980A/B had set the SRQ bus control line true. The byte is cleared after it is read by the HP-IB controller.	SPE SPD STB	T5
Status Bit	No	Does not respond to a parallel poll.	PPE PPC PPD PPU	PP0
Abort	Yes	Is unaddressed to listen or talk.	IFC	T5 L3
<p>1. Commands, Control lines and Interface Functions are defined in IEEE Std 488-1978. Knowledge of these might not be necessary if your controller's manual described programming in terms of the twelve HP-IB Meta Messages shown in the left column.</p> <p>2. The 1980A/B Oscilloscope Measurement System's complete bus capability as defined in IEEE Std 488-1978 is: SH1, AH1, T5, TE0, L3, LE0, SR1, RL1, PP0, DC0, DT1, CO, E2</p>				

3-23. HP-IB Status Display.

The status of the Measurement System on the HP-IB is annunciated on the CRT by a special HP-IB status advisory. For example, figure 3-8 shows the HP-IB status advisory displayed when the instrument is in remote mode and addressed to listen. The symbols displayed in the advisory and their indications are listed in table 3-4.



Table 3-4. Symbols Used in HP-IB Status Advisory

Advisory Symbol	HP-IB Status Indication
R	Switched to remote mode
L	Addressed to listen
T	Addressed to talk
S	Issued the Require Service message

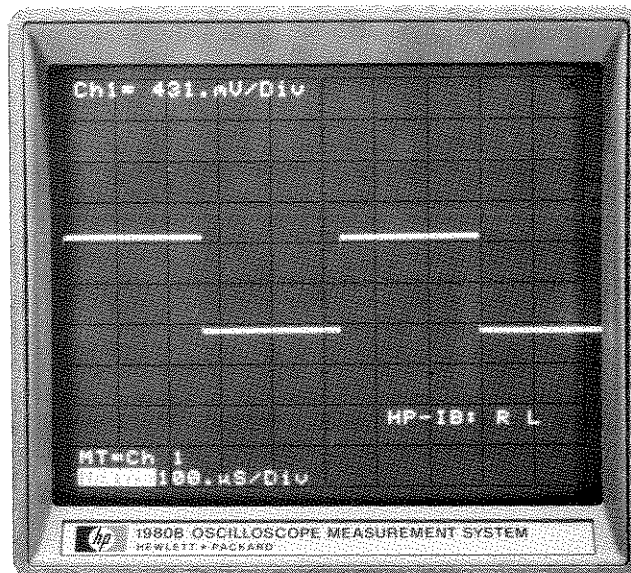

The HP-IB status advisory is normally enabled. (It is enabled by default at power-on and when the 19842A HP-IB menu is accessed.) The status advisory can be disabled by the remote operator; for further information, refer to the "HP-IB Status Advisory" Detailed Operating Instruction.



80-342

Figure 3-11. HP-IB Status Advisory

3-24. Remote Mode.

Remote Capability. The instrument communicates on the bus in both remote and local modes. In remote, all but a few of the front panel controls are disabled. The exceptions are the LINE switch, , , and the CRT display adjustments. When Local Lockout is in effect, the return-to-local key sequence () is also disabled.

The Control Knob can be enabled and assigned to specific functions while the instrument is in remote mode. This allows a local operator to make measurements or change settings under program direction. The procedure for this is described in the "Control Knob" Detailed Operating Instruction.

The Measurement System can be addressed to listen or talk while in remote mode. When addressed to listen, the instrument automatically stops talking and responds to Data messages. When addressed to talk, the instrument stops listening and sends either a Data message or the Status Byte. Whether addressed or not, the Measurement System responds to the Local, Local Lockout, Clear Lockout/Set Local, and Abort messages and, in addition, the Measurement System may issue the Require Service message. Although the 1980A/B does not respond to the Trigger message, this message is decoded and available for use by either plug-in or internal options.



Local-to-remote Mode Changes. The Measurement System switches to remote upon receipt of the Remote message. The Remote message has two parts:



- * Remote Enable (REN) bus control line true
- * Device listen address (MLA) received once while REN is true

All instrument settings remain unchanged with the local-to-remote transition. However, the remote-to-local transition does put the Control Knob in hold. If the HP-IB status advisory is enabled, \mathbb{R} is displayed in the status advisory to indicate remote mode.

If the Measurement System is set to listen-only or talk-only mode, the local-to-remote transition is inhibited.

3-25. Local Mode.

Local Capability. In local, the Measurement System's front panel controls are operational. Although it will not respond to input Data messages in local mode, if addressed to talk, the instrument can send Data messages and the Status Byte. Whether addressed or not, the instrument responds to the Remote, Local, Local Lockout, Clear Lockout/Set Local, and Abort messages. It also can issue the Require Service message in local mode.

Remote-to-local Mode Changes. The instrument always switches to local from remote whenever it receives the Local message (GTL) or the Clear Lockout/Set Local message. (The Clear Lockout/Set Local message sets the Remote Enable control line [REN] false.) If it is not in Local Lockout mode, the instrument also switches to local from remote when the key sequence   is pressed.

The instrument's settings remain unchanged during remote-to-local transitions. If the HP-IB status advisory is enabled, the remote indicator (\mathbb{R}) turns off as the remote-to-local change is made.

3-26. Local Lockout.

When program control is interrupted, which can happen by returning the instrument to local via the front panel keystroke sequence, data or settings could be changed. This would leave the instrument in an unknown state. To prevent this, a local lockout is recommended. Local lockout allows return-to-local only under program control.

Note

Return-to-local can also be accomplished by turning the instrument off, then on again with the LINE switch. However, this technique has several potential disadvantages:

- * It defeats the purpose of local lockout (that is, the system controller may lose control of the instrument).
- * Other HP-IB conditions reset to default states at power-on.

3-27. Addressing.

The Measurement System interprets the byte on the eight bus data lines as an address or a bus command if the bus is in the command mode (Attention control line [ATN] true). In addressable mode, the instrument may be addressed to listen or to talk.



Once addressed to listen, the instrument remains configured to listen until it receives an Abort message (IFC), its own talk address (MTA), or a universal unlisten command (UNL) from the controller. Once addressed to talk, the instrument remains configured to talk until it receives an Abort message (IFC), another instrument's talk address (OTA), its own listen address (MLA), or a universal untalk command (UNT). If the status advisory is enabled, it indicates on the CRT when the instrument is addressed to talk (T) or addressed to listen (L).

The Measurement System is shipped from the factory in the addressable mode, with its talk and listen addresses set to "7" (ie, T7 and L7). Refer to table 3-30 for equivalent address codes. The instrument can also be configured in the talk-only or listen-only mode. These modes enable limited bus operation without an HP-IB system controller. The instrument's address and addressing mode may be displayed or changed from the front panel using the soft keys. Complete instructions for these procedures are in the "HP-IB Address" Detailed Operating Instruction.

Listen-only Mode. If the instrument is set to listen-only mode, it is always configured as a listener and responds to all Data messages sent on the HP-IB. However, it cannot output Data messages and it is inhibited from responding to the Remote, Local, Local Lockout, Clear Lockout/Set Local, or Abort messages. Also, it is disabled from issuing the Require Service message and cannot respond to a serial poll.

Note

In listen-only mode, the front panel is enabled (the instrument does not enter remote mode). Therefore, settings can be changed while a program is executing.

Talk-only Mode. If the Measurement System is set to talk-only mode, it is always configured as a talker and does not respond to any of the bus messages. Although the talk-only mode may be selected from the front panel, it is not supported by the 1980A/B standard firmware.

3-28. HP-IB Turn-on Default Conditions.

Several HP-IB parameters are reset at power-on. However, both the instrument's address and addressing mode are preserved in nonvolatile memory.

HP-IB parameter default conditions are:

- * HP-IB local mode
- * Local-lockout cleared
- * Unaddressed (if in normal addressing mode)
- * RQS mask cleared
- * Service Request message cleared
- * Status byte register cleared
- * HP-IB status advisory enabled



3-29. Data Messages.

The Measurement System communicates on the HP-IB primarily with Data messages. The Measurement System interprets the byte on the eight bus data lines as a Data message when the bus is in the data mode (Attention control line |ATN false).

The instrument can both receive and send Data messages. Input Data messages include the instrument's program codes (device-dependent commands) used to program front panel functions, menu functions, and all remote functions. Output Data messages include instrument status information and the settings of specific functions.

Of special consideration is the Learn String which can be sent and received by the instrument. It is a binary data string that contains a condensed coding of the entire instrument state. The Learn String is described in paragraph 3-32 and in the "Learn Mode" Detailed Operating Instruction.

The HP-IB Codes and Format Summary (paragraph 3-55) provides a list of all program codes for the 1980A/B. This summary includes a brief description of each code, specific format requirements, and a cross reference to further information in the Detailed Operating Instructions.

3-30. Receiving the Data Message.

The Measurement System responds to Data messages when in remote mode (REN control line true) and is addressed to listen or when it is in listen-only mode.

Input Data Message Format. Input Data messages contain a string of device dependent commands (program codes) and an End-of-String (EOS) message. The program codes within a Data message are executed after the EOS message is received. The following format rules must be observed in all input Data messages:

- * A linefeed (<LF>) is used as the End-of-String (EOS) message. Each Data message must be terminated by a (<LF>).
- * Except during Learn String transfers, the carriage return character (<CR>) is not required before <LF>. Preceding <LF>, <CR> is treated as "no operation" and may be repeated as many times as permitted by the maximum string length limitation.
- * When several program codes are sent in a Data message, a semicolon (;) must be used to delimit each program code except the last one in the string.
- * Spaces (<SP>) are not allowed within input Data messages except as defined in the program code format description.
- * The maximum length of a Data message string is 127 characters (including: semicolons, commas, <SP>, <CR>, and <LF>).

Errors in Data message syntax are trapped and can be reported via The HP-IB. For details about detecting and reporting format errors refer to the "HP-IB Syntax Errors" Detailed Operating Instruction.



General Input Data Message Format:

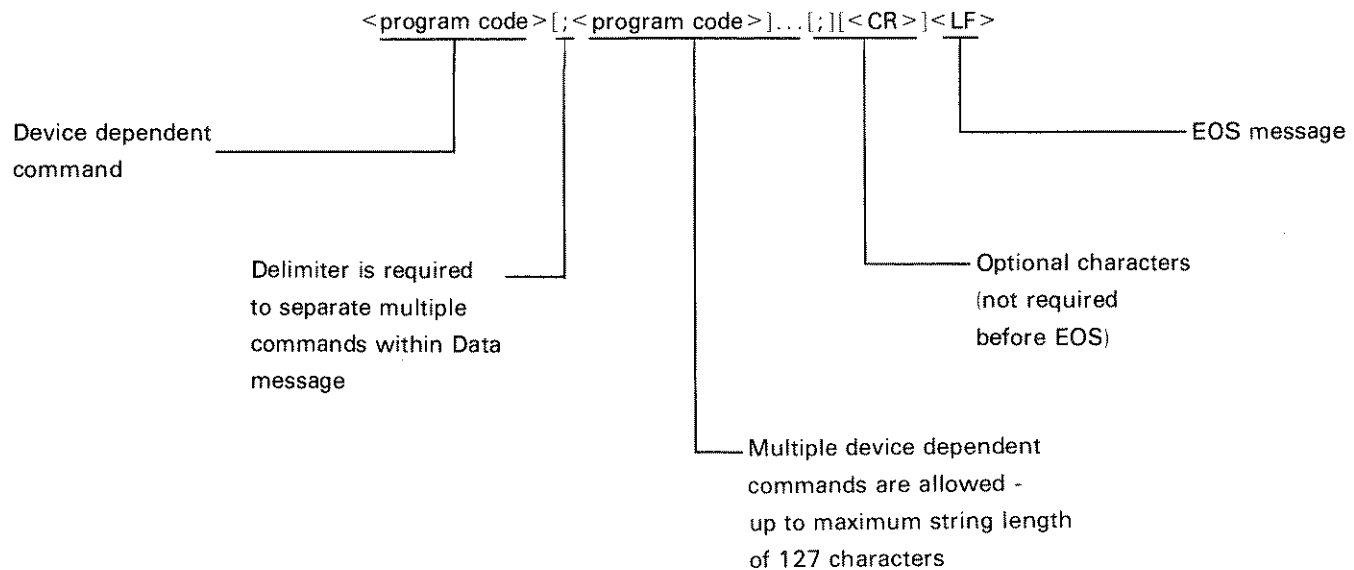

Program Order Considerations. Measurement System functions may be programmed in practically any order from the HP-IB. However, it is recommended that program code sequences should be in the same order used for front-panel operation. Generally, this requires that functions be set up starting with the most basic parameter to be changed. For example, before entering channel 2 deflection factor, turn on channel 2.

If a plug-in or internal option for the instrument imposes any other order considerations, the manual for that option provides the necessary programming information.

Table 3-5 lists typical processing times for some sample Data messages. To minimize the processing time in a given application, use the learn string and save/recall registers to establish instrument configuration. When sending a series of program codes to the 1980A/B, processing time can be reduced by combining them into as few Data messages as possible. For example, note the execution time for the last two Data messages in table 3-5.

Program Code Format. Program codes consist of a two letter function identifier (i.e., prefix) and a parameter field. Suffixes are not used in 1980A/B program codes. The two letter identifier is a mnemonic that defines the major instrument function being addressed. Depending upon the identifier, the associated parameter field may contain zero, one, or multiple parameters. The general rules of program code format are:

- * The 1980A/B sends and receives Data messages in standard ASCII code.
- * The instrument responds equally to upper and lower case characters.
- * Parameter fields containing multiple parameters require a comma (,) to delimit individual parameters.
- * Program codes are space sensitive. Within program codes, spaces are accepted only immediately following function identifiers or parameter delimiters. (Exponential numeric entries use the character "E" or "e" as a delimiter between the mantissa and the exponent; spaces may follow "E", "e", or comma.)

Program code parameters are of five types, these are: integers, decimals, exponentials, ASCII character strings, and binary data. Integer, decimal, and exponential parameters can be signed or unsigned. Specific format requirements for all program codes are given in the Detailed Operating Instructions section of this manual. They are also condensed in the HP-IB Codes and Format Summary.

Errors in program code format can be trapped and reported via the HP-IB. Refer to the "HP-IB Syntax Errors" Detailed Operating Instruction for a description of how to detect and report program code format errors.



Table 3-5. Typical Processing Times for Various Commands

Data Message	Execution Time* (Typical)	Function/Comments
SK7,1 <CR><LF>	450 msec	Recall instrument state from register 1.
SK6,1 <CR><LF>	200 msec	Save instrument state in register 1.
IN <CR><LF>	380 msec	Execute initialize.
AS <CR><LF>	3.2 sec	Execute autoscope, calibrator connected to both channel 1 and 2.
SA <CR><LF>	2.7 sec	Execute selective autoscope, one channel on with calibrator connected.
TX1, <any string>	20 msec	Write text on line 1 of the CRT text field.
RC1,1 <CR><LF>	64 msec	Assign Control Knob to channel 1 deflection factor, fine resolution.
VM2 <CR><LF>	70 msec	Turn on channel 2 only.
VS1,+2.00 E-3 <CR><LF>	40 msec	Enter channel 1 deflection factor of 2 mV/div. If polarity change is made, add 54 msec.
VC1,2 <CR><LF>	82 msec	Select DC coupling for channel 1.
HM2 <CR><LF>	114 msec	Select intensified horizontal mode; time given is for change from main mode.
HM3 <CR><LF>	70 msec	Select delayed horizontal mode, time given is for change from intensified mode.
MS50.0E-6 <CR><LF>	55 msec	Enter main sweep speed of 50 μ sec/div.
DY200E-3 <CR><LF>	50 msec	Enter delay time of 200 msec.
DL200 <CR><LF>	28 msec	Enter delayed trigger level of 2 div, internal source selected.
VM2;VC2,2;VS2,+2.00E-3 <CR><LF>	140 msec	Enter channel 2 coupling and sensitivity. Note the execution time improvement when several program codes are sent in a single Data message.
HM2;MS50.0E-6;MM1; MT+1,4;ML200 <CR><LF>	260 msec	Select horizontal mode and main sweep speed, mode, trigger source, slope, level, and coupling.

*Execution time is measured from receipt of EOS message (<LF>). Maximum data input rate is 127 μ sec/character.

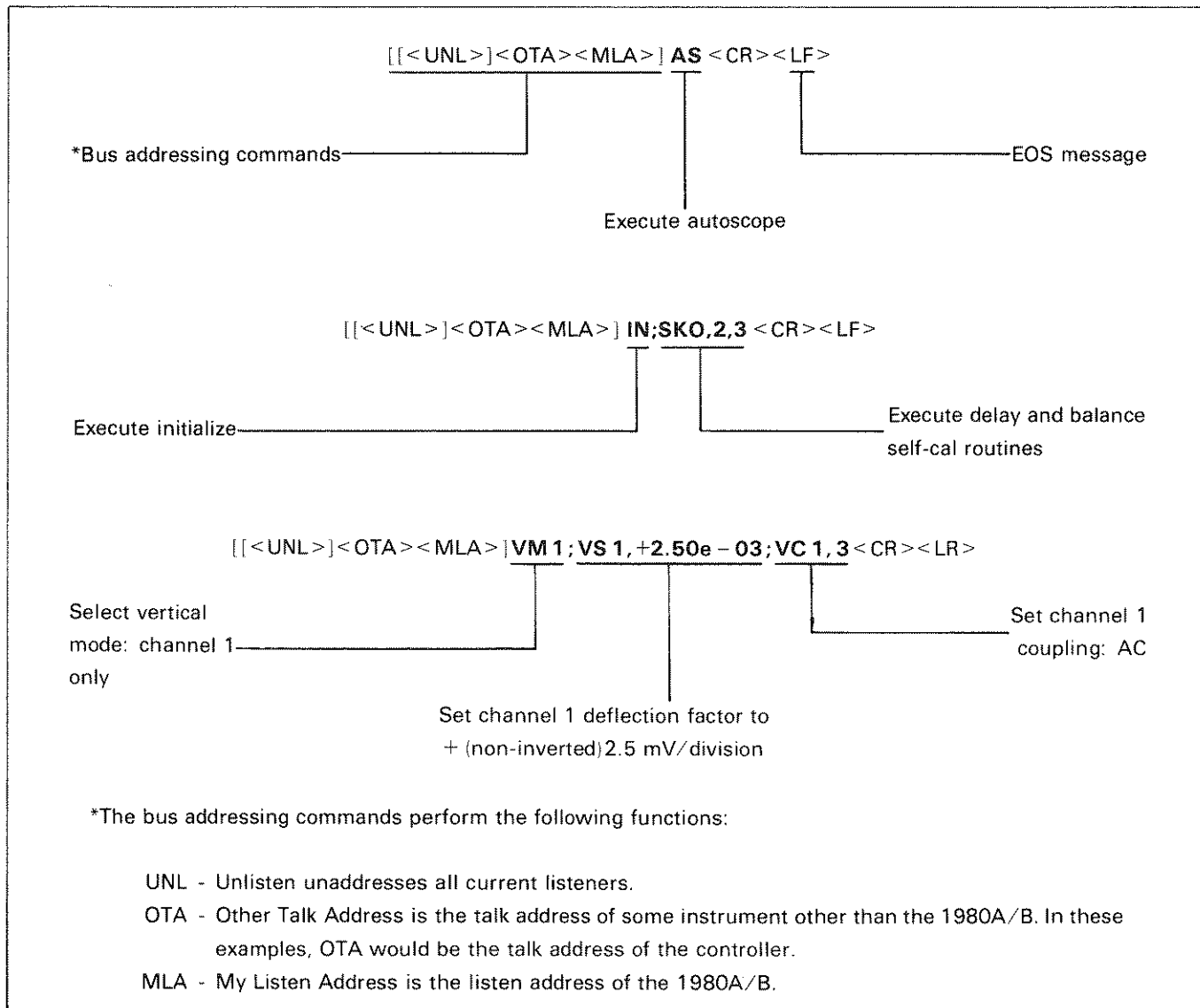

Figure 3-12. 1980A/B Input Data Message Examples

3-31. Sending the Data Message.

The instrument can send Data messages in local or remote mode, when it is addressed to talk or in the talk-only mode.

Note

Before the instrument is addressed to talk, the desired output data must be specified with the appropriate input Data message. Otherwise, the Measurement System outputs the ASCII character "E" by default to complete the bus transaction.

Output Data Message Format. Output Data messages include the settings of individual functions, instrument status information or binary Learn String data. Excluding the Learn String, there are three output data types: Integer, decimal, and exponential. All output Data messages contain a leading space (<SP>) followed by the function value or status data. <CR> and <LF> are sent as the EOS message for all output data except the Learn String. The Learn String uses the EOI bus control line to signal end-of-string.



For more information about output Data messages, refer to the "Reading Values Via HP-IB", "Instrument Status", and "Learn Mode" Detailed Operating Instructions.

Note

Exponential values are sent by the 1980A/B with the ASCII character "E" (uppercase) as the delimiter between the mantissa and the exponent.

General Output Data Message Format:

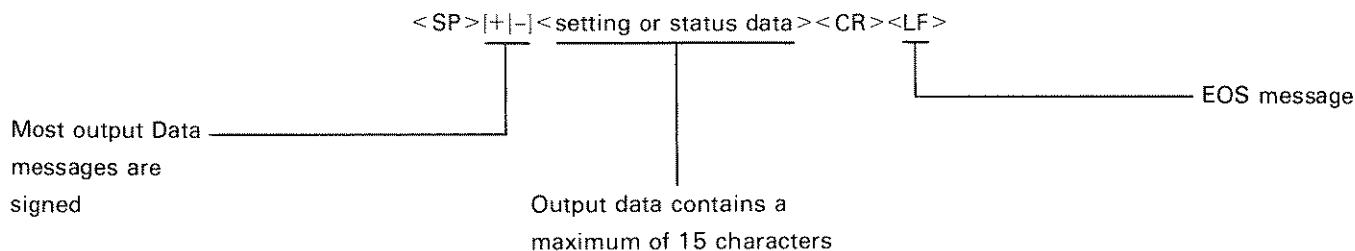

3-32. Learn Mode.

If the Measurement System receives a "TE" (Teach) program code and is then addressed to talk, it sends the Learn String. The Learn String consists of 80, 8-bit bytes containing information about front panel configuration. This binary data can be stored in the controller's memory for future use. The Learn String includes only those parameters that can be stored in the instrument's internal Save/Recall registers. The contents of the Save/Recall registers, however, are not included in the Learn String. Refer to the "Save/Recall" Detailed Operating Instruction for information about register limitations.

Note

The 80th byte of the Learn String is sent with the bus EOI line true, to indicate end-of-string.

When the Measurement System is addressed to listen, the binary data can be returned to it in a 80 byte string. The Measurement System interprets the first two bytes to determine that this is a Learn string. Following the 80th byte, the transfer must be terminated with < CR> and < LF>. When the < LF> is received, the instrument changes state according to the Learn String contents.

Note

During the transfer of the Learn String, the instrument can not be readdressed. If it is the transfer will be aborted. The 80 byte string should be sent or read by the controller using a technique that does not readdress bus devices.

For more information about using the Learn String, refer to the "Learn Mode" Detailed Operating Instruction.

3-33. Receiving the Clear Message.

The Measurement System does not respond to the Clear message. However, the instrument can be placed in a known state using the Preset menu function (HP-IB "IN" program code). Refer to the "Initialize" Detailed Operating Instruction for more information.



3-34. Receiving the Trigger Message.

The 1980A/B does not respond to the Trigger message (GET bus command), although the message is received and available to internal and plug-in options.

3-35. Receiving the Remote Message.

The Remote message has two parts. First, the remote enable bus control line (REN) is held true, then the device listen address is sent by the controller. The Measurement System is enabled to go into remote when REN goes true but it does not actually switch into remote until addressed to listen the first time. No instrument settings are changed by the transition from local to remote, but the Control Knob is placed in hold. When actually in remote mode, the Measurement System displays \mathbb{R} in the HP-IB status advisory to indicate remote mode.

3-36. Receiving the Local Message.

The Local message returns the Measurement System to front panel control. The Local message (GTL bus command) addresses the instrument to listen and then switches it from remote to local mode. If the HP-IB status advisory is enabled, the remote indicator (\mathbb{R}) will turn off when the Local message is received. No instrument settings are changed by the remote-to-local transition.

Although the Local message returns front panel control, it does not clear local lockout. Unless the instrument receives the Clear Lockout/Set Local message, if local lockout is in effect, it will return to local lockout mode the next time it goes to remote.

3-37. Receiving the Local Lockout Message.

The Local Lockout message (LLO bus command) disables the Measurement System's front panel return-to-local keystroke sequence. Local Lockout is accepted when the instrument is in either remote or local mode. Afterwards, whenever the instrument is in remote mode, lockout is in effect. While the instrument is in local lockout, the remote-to-local transition can only be made from the system controller by sending the Clear Lockout/Set Local message or the Local message.

3-38. Receiving the Clear Lockout/Set Local Message.

The Clear Lockout/Set Local message (REN control line false) returns the Measurement System from remote to local mode and clears the local lockout condition. No instrument settings are changed by this message. It is accepted while the instrument is in either remote or local mode. If the instrument is in remote mode, the remote indicator (\mathbb{R}) is blanked when the Clear Lockout/Set Local message is received.

3-39. Receiving the Pass Control Message.

The instrument does not implement the controller subset, therefore, it does not respond to the Pass Control message.

3-40. Sending the Require Service Message.

The Measurement System sends the Require Service message (by setting the SRQ bus control line and bit 7 of the status byte true) when a previously programmed condition occurs. The instrument can send the Require Service message in either local or remote mode. The Require Service message is cleared when a serial poll is executed by the system controller. During serial poll, the SRQ control line is reset immediately before the instrument places the Status Byte message on the bus. Figure 3-13



includes the conditions that can be selected to cause the Require Service message. If no conditions are selected, the Require Service message is disabled.

The Measurement System indicates having sent the Require Service message by displaying \mathcal{S} in the HP-IB status advisory. This indicator is turned off during the serial poll when the SRQ control line is reset.

If the Measurement System is set to either listen-only or talk-only mode, it can not send the Require Service message.

For complete information about programming the condition that causes the Require Service message, refer to the "Service Request Condition" Detailed Operating Instruction.

Bit	8	7	6	5	4	3	2	1
Mask Weight	128	64	32	16	8	4	2	1
Service Request Condition	SRQ Key	RQS Bit	Plug-in Option Request	Internal Option Request	Advisory or Error	End of Sweep	Key Closure	HP-IB Syntax Error
<p>Notes: 1. To set the RQS bit and SRQ bus control line true, the condition must be enabled in the RQS mask.</p> <p>2. If no condition is enabled, the 1980A/B can not set the SRQ bus control line nor the RQS bit true. However, bits 1-6 and 8 of the status byte are set to indicate which conditions have occurred.</p>								

Figure 3-13. The Status Byte and the RQS Mask

3-41. Sending the Status Byte Message.

The Status Byte message consists of one 8-bit byte in which the bits are set according to the conditions described in figure 3-13. The Measurement System sends the Status Byte message when it is addressed to talk and it receives the Serial Poll Enable (SPE) bus command from the HP-IB system controller. After the message is transferred to the controller, all bits are cleared by the Serial Poll Disable (SPD) bus command, the Abort message, or if the instrument is unaddressed to talk.

If the instrument is set to either listen-only or talk-only mode, it does not respond to the SPE or SPD commands and can not send the Status Byte.

The Measurement System has two modes for transferring status information with the status byte:

If the Required Service message is not enabled (that is, if the RQS mask value is 0), a single status byte is available from the instrument. The bits in this byte are set to indicate all conditions that have occurred since the byte was last reset. In this mode, the RQS bit (bit 7 of the status byte) is always false. Figure 3-14 contains a typical flowchart for reading instrument status when the Require Service message is disabled.

If the Require Service message is enabled, as many as nine separate occurrences can be queued in a status byte register stack. Each byte in the stack has two bits set true: The RQS bit (bit 7) and the bit corresponding to the condition that occurred. The status register stack is read on a first-in, first-out basis by serial polling the Measurement System repetitively until it does not send the Require Service message. If there are more than nine occurrences before the register stack is read, the stack will contain the codes for the first eight conditions and for the last condition that occurred. Figure 3-15 contains a flowchart for reading instrument status using the Require Service message.

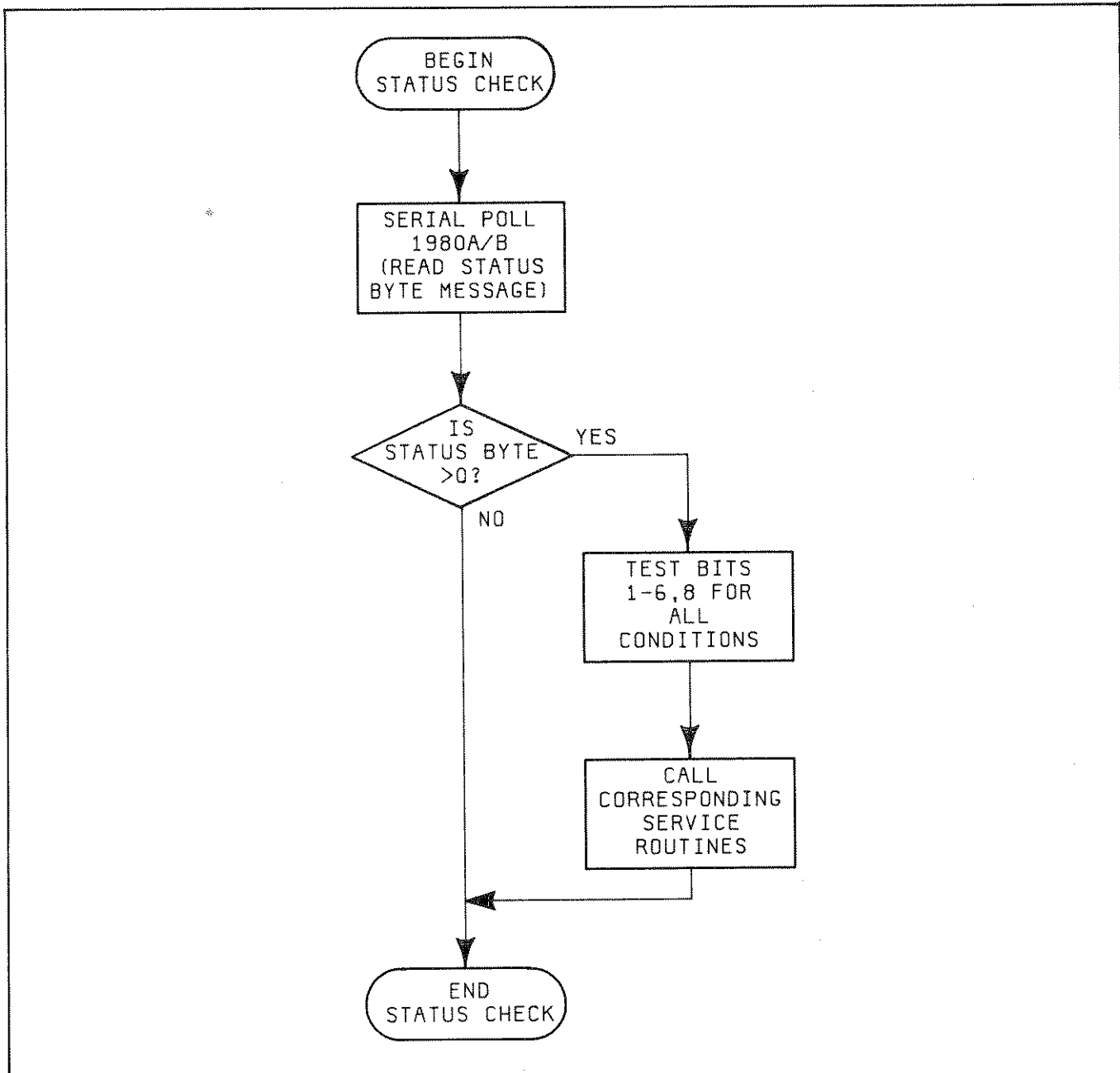

Figure 3-14. Serial Poll With Require Service Message Disabled (RQS Mask Value = 0)

To supplement the information in the Status Byte, there are status qualifier registers that can be read to determine which error occurred, which key was pressed, etc. For more information about using the status reporting features of the Measurement System, refer to the "Instrument Status" Detailed Operating Instruction.

3-42. Sending the Status Bit Message.

The Measurement System does not respond to a Parallel Poll Enable (PPE) bus command; it cannot send the Status Bit message.

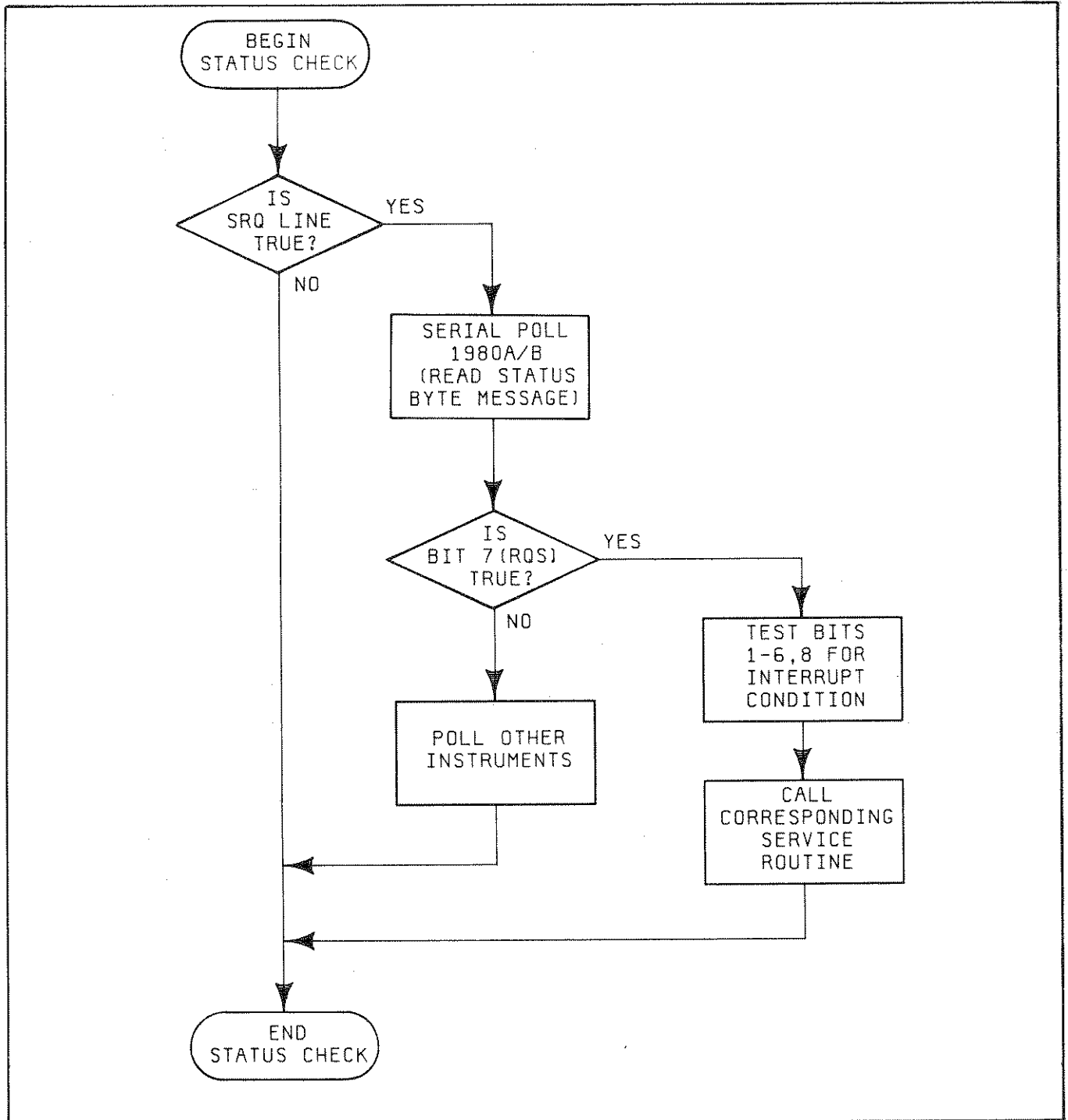

Figure 3-15. Serial Poll Using the Require Service Message (RQS Mask Value > 0)



3-43. Receiving the Abort Message.



The Abort message (IFC control line true) halts all bus activity. When the Measurement System receives the Abort message it becomes unaddressed and stops talking or listening. The Require Service message and the Status Byte are unaffected by the Abort message.

3-44. OPERATOR'S CHECKS.

3-45. Confidence Test.

Description Confidence Test can be executed from the front-panel to confirm that the internal 1980A/B hardware and software is functional. This test does not verify that the 1980A/B is operating to specifications. Only a probe or BNC cable is required to execute Confidence Test.

Procedure Select the CONFIDENCE TEST menu by pressing   CONFIDENCE TEST 1980A/B.

Then, connect the calibrator signal to the vertical channel to be tested. To execute the test, press any key except  or .

To exit the CONFIDENCE TEST menu without performing the test, press  PREVIOUS MENU.

Indication If the instrument passes the Confidence Test, the PASSED TEST advisory message is displayed on the CRT.

If the instrument fails the Confidence Test, an error message is displayed in the LED Readout that indicates which failure was detected. The test is then aborted, the 1980A/B executes an autoscope to initialize itself, and the advisory FAILED TEST is displayed. The error messages that may be displayed during the Confidence Test are listed in table 3-6.







If no signal is applied to either input channel when the Confidence Test is executed, the advisory message SIGNAL NOT FOUND is displayed on the CRT in addition to the error message .

Table 3-6. Confidence Test Error Messages

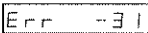
Error Message	Error Description
	No signal found at channel 1 or 2.
	Horizontal range error
	10V range error
	1V range error
	0.1 range error
	0.02 range error

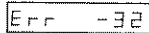
Response If a failure is detected by the Confidence Test, the instrument might be useable but it does require servicing.

Comments At the end of the Confidence Test, the Measurement System executes an autoscope on the calibrator signal (at output level of 1 Vp-p). Previous front-panel settings are not preserved by this test. However, the Save/Recall registers and HP-IB status information are not changed.



The Confidence Test requires a front panel key closure to execute. The test cannot be executed via the HP-IB.

 can not be used to turn off the menus when the CONFIDENCE TEST 1980A/B menu is displayed.

3-46. Memory Check.

Description There are two memory checks: ROM Checksum and RAM Test. These checks assure that the 1980A/B memory is operating properly and that it contains valid data.

Procedure Both memory checks are in the UTILITIES menu which is called with the key sequence:

 CALIBRATE & UTILITIES
 UTILITIES

To execute ROM Checksum, select the UTILITIES menu, then press  ROM CHECKSUM. This routine can also be executed via the HP-IB by sending the Data message:

IN;SK0,2,4,6 <CR><LF>

To execute the RAM Test routine, select the UTILITIES menu, then press  RAM TEST. This check can also be executed via the HP-IB by sending the Data message:

IN;SK0,2,4,5 <CR><LF>

Indication When the instrument passes either the ROM Checksum or RAM Test, the advisory PASSED TEST is displayed on the CRT.

If the instrument fails a ROM Checksum or RAM Test, an error message is displayed in the LED readout that indicates where in memory the failure occurred. When the first error is detected, the routine is aborted and the advisory FAILED TEST is displayed.

Response If the instrument fails either the ROM Checksum or the RAM Test, it might be useable, but it does require servicing.

Comments Executing either the ROM Checksum or the RAM Test causes the advisory messages to be enabled. However, there are no other changes in instrument front-panel settings or status.

3-47. HP-IB I/O Check.

Description The following procedures check the Oscilloscope Measurement System's ability to process or send all of the applicable HP-IB messages described in table 3-3. In addition, the instrument's ability to recognize its HP-IB address is checked and all of the bus data, handshake, and control lines except DIO8 are set to both their true and false states. These procedures do not check whether or not all Measurement System program codes are being properly interpreted and executed by the instrument, however, if front panel operation is correct, the program codes, in all likelihood are correctly implemented.

The validity of these checks is based upon the following assumptions:

- * The instrument performs correctly when operated in local mode. This can be verified with the Confidence Test and the Memory Check (ROM Checksum and RAM Test) procedures in paragraphs 3-45 and 3-46 respectively.
- * The bus controller properly executes HP-IB operations as defined by IEEE Std. 488.
- * The bus controller's HP-IB interface properly executes the HP-IB operations.

If the Measurement System appears to fail any of these HP-IB checks, the validity of the above assumptions should be confirmed before attempting to service the instrument.

The controller's HP-IB interface select code is assumed to be "7". The Measurement System is assumed to be in the addressable mode with address "7" (T7/L7) selected. This select code-address combination (that is, 707) is not necessary for these checks to be valid. However, program lines in this procedure would have to be modified for any other combination.

These checks are intended to be as independent of each other as possible. Nevertheless, the first four checks should be performed in order before the other checks. Any special initialization or requirements for a check are described at its beginning.

Equipment HP-IB Controller HP 9825/98213A (General and Extended I/O ROM)
 -or- HP 9835/98332A (I/O ROM)
 -or- HP 9845 (with HP-IB I/O)

HP-IB Interface HP 98034A (revised)

Setup Connect the Measurement System to the bus controller via the HP-IB Interface.



Procedure **Address Recognition.** This check determines if the Measurement System recognizes when it is being addressed and when it is not. This check assumes only that the instrument can properly handshake on the bus. Before beginning this check, set the Measurement System LINE switch to OFF, then to ON.

Description	HP 9825 (HPL)	HP 9835/45 (BASIC)
Set Remote Enable (REN) line false.	lcl 7	LOCAL 7
Send the 1980A/B listen address.	wrt 707	OUTPUT 707

The HP-IB status advisory should read: HP-IB: L

Unaddress 1980A/B by sending a different listen address.	wrt 721	OUTPUT 721
----------------------------------------------------------	---------	------------

The HP-IB status advisory should turn off.

Remote and Local messages and  This check determines if the Measurement System properly switches from local to remote control, from remote to local control, and whether the key sequence:  returns the instrument to local control. This check assumes that the Measurement System is able to both handshake and recognize its own address. Before beginning this check, set the Measurement System LINE switch to OFF, then to ON.



Description	HP 9825 (HPL)	HP 9835/45 (BASIC)
Send Remote message by setting the REN line true and addressing 1980A/B to listen.	rem 707	REMOTE 707

The HP-IB status advisory should read: HP-IB: RL

Send Local message to 1980A/B.	lcl 707	LOCAL 707
--------------------------------	---------	-----------

The HP-IB status advisory should read: HP-IB: L

Send Remote message to 1980A/B.	rem 707	REMOTE 707
---------------------------------	---------	------------



HP-IB status advisory should read: HP-IB: RL

Press . The status advisory should change to read: HP-IB: L

Receiving the Data Message. This check determines if the Measurement System properly receives Data messages. This check assumes the instrument is able to handshake, recognize its own address, and properly make the remote/local transition. Before beginning this check, set the Measurement System LINE switch to OFF, then to ON.

Description	HP 9825 (HPL)	HP 9835/45 (BASIC)
Set REN line true.	rem 7	REMOTE 7
Address 1980A/B to listen and send the Data message "execute autoscope".	wrt 707, "AS"	OUTPUT 707; "AS"

Check that the instrument executes an autoscope and that the HP-IB status advisory reads: HP-IB: RL

Sending the Data Message. This check determines if the Measurement System properly sends Data messages. It also verifies the the 7 least significant HP-IB data lines can be sent and received in both their true and false states. This check assumes the instrument is able to handshake, recognize its own address, make remote/local transitions, and receive Data messages. Before beginning this check, set the Measurement System LINE switch to OFF, then to ON and press   PRESET.



Description	HP 9825 (HPL)	HP 9835/45 (BASIC)
Send Remote message to 1980A/B.	rem 707	REMOTE 707
Send a Data message to 1980A/B which instructs it to output the value of channel 2 deflection factor.	wrt 707, "OF2"	OUTPUT 707; "OF2"
Address 1980A/B to talk and store its output data in variable A.	red 707, A	ENTER 707; A
Display value of A	dsp A	DISP A

The HP-IB status advisory should read: HP-IB: RT
 The controller's display should read 2.00 (9825) or 2 (9835/45)

Local Lockout and Clear Lockout/Set Local Messages. This check determines if the Measurement System properly receives the Local Lockout message and the Clear Lockout/Set Local message. This check assumes that the Measurement System is able to handshake, recognize its own address, and properly make the remote/local transitions. Before beginning this check, set the Measurement System LINE switch to OFF, then to ON.

Description	HP 9825 (HPL)	HP 9835/45 (BASIC)
Send Remote message to 1980A/B.	rem 707	REMOTE 707
Send Local Lockout message.	llo 7	LOCAL LOCKOUT 7

The HP-IB status advisory should read: HP-IB: RL

Press: . Advisory SCOPE UNDER REMOTE CONTROL should be displayed and the status advisory should remain unchanged.

Send the Clear Lockout/Set Local message.	lcl 7	LOCAL 7
-------------------------------------------	-------	---------

HP-IB status advisory should read: HP-IB: L

Set REN line true.	rem 7	REMOTE 7
Address the 1980A/B to listen.	wrt 707	OUTPUT 707

Press: . The HP-IB status advisory should read:



Abort Message. This check determines if the Measurement System becomes unaddressed when it receives the Abort message. This check assumes that the instrument is able to handshake, recognize its own address, and make the remote/local transitions. Before beginning this check, set the Measurement System LINE switch to OFF, then to ON.

Description	HP 9825 (HPL)	HP 9835/45 (BASIC)
Send the Remote message to 1980A/B.	rem 707	REMOTE 707

HP-IB status advisory should read: HP-IB: RL

Send the Abort message unaddressing 1980A/B.	cli 7	ABORTIO 7
----------------------------------------------	-------	-----------

If using a HP 9825, check that the HP-IB status advisory reads: HP-IB: R. If using a HP 9835 (or 9845), check that the HP-IB status advisory is turned off. (The 9835 and 9845 send the Local message and the Abort message with the ABORTIO command.)

Send Local message (HP 9825 only).	lcl 707	The Local message was sent with ABORTIO statement.
Address 1980A/B to talk.	red 707	ENTER 707
Send Abort message unaddressing 1980A/B.	cli 7	ABORTIO 7

Check that the HP-IB status advisory is off.

Require Service Message. This check determines if the Measurement System can issue the Require Service message (set the SRQ bus line true). This check assumes that the Measurement System is able to handshake, recognize its own address, make remote/local transitions, and receive Data messages. Before beginning this check, set the Measurement System LINE switch to OFF, then to ON.

Description	HP 9825 (HPL)	HP 9835/45 (BASIC)
Set REN line true.	rem 7	REMOTE 7
Address 1980A/B to listen and send a Data message enabling a Require Service message to be sent if a key closure occurs.	wrt 707, "IM2"	OUTPUT 707; "IM2"

Press . HP-IB status advisory should read: HP-IB: RLS



Read binary status of the controller's HP-IB interface and store data in variable A.	rds(7)->A	STATUS 7; A
Display value of SRQ bit.	dsp "SRQ=", bit (7,A)	DISP "SRQ="; BIT (A,7)

The SRQ value should be displayed as 1.00 (9825) or 1 (9835/45), indicating that the Measurement System issued the Require Service message.

Status Byte Message. This check determines if the Measurement System sends the Status Byte message in both local and remote modes. This check assumes that the Measurement System is able to handshake, recognize its own address, and make local/remote transitions. Before beginning this check, set the Measurement System LINE switch to OFF, then to ON.

Description	HP 9825 (HPL)	HP 9835/45 (BASIC)
Conduct a serial-poll and display Status Byte value.	rds (707)	STATUS 707; A DISP A

Check that the HP-IB status advisory remains off and the controller display reads 0.00 (HP 9825) or 0 (HP 9835 and 9845).

Press .

Send Remote message to 1980A/B.	rem 707	REMOTE 707
Conduct a serial-poll and display Status Byte value.	rds (707)	STATUS 707; A DISP A

HP-IB status advisory should read: HP-IB: RL

Controller display should read 130.00 (HP 9825) or 130 (HP 9835/45).

3-48. OPERATOR'S CALIBRATION AND ADJUSTMENT.

3-49. Delay Time Self-cal.

Description To maintain the specified delay time performance, execute the following delay self-calibration procedure approximately once each hour.

Procedure The delay time self-cal can be executed with the key sequence:

CALIBRATE & UTILITIES
 DELAY SELF CAL

It can also be executed via the HP-IB by sending the Data message:

IN: SK 0, 2, 1 <CR><LF>

Indication As the delay self-cal is executing, the LED readout displays a number which represents the relative delay drift. As the drift is nulled, this displayed number approaches zero. When the self-cal routine is finished, the Measurement System is restored to the settings it had before the self-cal was initiated.

If the drift cannot be corrected by the self-cal routine, the instrument executes the self-cal repetitively until a key is pressed or the LINE switch is cycled OFF and ON.



To express the delay drift in terms of percentage error, divide the value displayed in the LED readout by 1999.87. For example, if the value "30" is displayed, the drift is: $30/1999.87 = 0.015\%$

Response If the self-calibration routine cannot correct the drift entirely, internal adjustment is required. Although the Measurement System may still be functional, it does require servicing.

3-50. Vertical Balance Self-cal.

Description The vertical balance self-cal routine nulls gain dependent offsets in the vertical pre-amplifiers. The self-cal routine virtually eliminates baseline shift as vertical deflection factor is changed. The balance self-cal should be performed whenever there is noticeable shift of the vertical baseline as deflection factor is changed.

Procedure To execute the balance self-cal from the front panel of the 1980A/B, press the following key sequence:

 CALIBRATE & UTILITIES
 BALANCE SELF-CAL

The balance self-cal can be executed via HP-IB by sending the Data message:

IN;SK 0, 2, 2 <CR><LF>

Note

Do not apply any signals to channel 1 or 2 inputs while executing the balance self-cal procedure.

Indication While balance self-cal is executing, advisory message `BALANCE SELF-CAL CH1` (or `CH2`) is displayed on the CRT. When the balance routine is finished, the Measurement System is restored to the same settings it had before the self-cal was initiated.

If the balance routine cannot calibrate one of the vertical channels, an error message is displayed in the LED readout to indicate which channel failed. The instrument can be programmed to issue the Require Service message to signal this failure, see the "Error Messages" and "Service Request Condition" Detailed Operating Instructions for further information.

Response Although a vertical balance self-cal failure indicates the Measurement System should be checked by qualified service personnel, the accuracy of measurements taken with the instrument are not impaired.

3-51. CRT Adjustments.

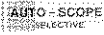

Description Controls are provided on the front-panel of the 1980A/B for operator adjustment of the CRT display. Because trace alignment with the graticule is affected by the orientation of the instrument with the ambient magnetic field, the display may have to be realigned after the instrument is installed or moved. The ASTIG and FOCUS controls may have to be periodically adjusted for optimum focus.

Procedure **Trace Alignment.** With no signal applied to either vertical channel input, press .

Using a small screwdriver or alignment tool, adjust the front-panel ALIGN control (on CONTROL panel) for best alignment of trace with horizontal graticule lines.

Astigmatism and Focus. Set trace intensity to level 22, press  and adjust with the Control Knob.

Select 1 vs 2 scope mode, press .

Ground channel 1 and 2 inputs, press  (ch 1),  (ch 2).

Adjust ASTIG control for best spot shape (i.e., most radially symmetric spot).

Adjust FOCUS control for smallest spot and for well defined characters.

3-52. Probe Compensation.

Description Probe compensation may be required because of variations in total input resistance and capacitance from one instrument or input to another. To compensate a probe, proceed as follows:

Procedure Connect probe to the input of vertical channel 1.

Connect the probe tip to the front-panel calibrator terminal.

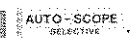
Select DC coupling for channel 1, then execute a selective autoscope. Press  (ch 1) .

Adjust divider probe low frequency compensation for correct display (figure 3-16).

3-53. DETAILED OPERATING INSTRUCTIONS.

3-54. Using the Detailed Operating Instructions.

These Detailed Operating Instructions contain all the information needed to operate the 1980A/B. The instructions are arranged alphabetically; a functional index appears in table 3-1.

The following considerations should be remembered when using the Detailed Operating Instructions:

- * Procedures and examples assume the instrument is in the initialized state (refer to the "Initialize" instruction).
- * The procedures and examples for HP-IB operation include only the program codes (device dependent commands) needed for remote operation. The HP-IB command mode messages (such as REN, MLA, MTA, and UNL) that are

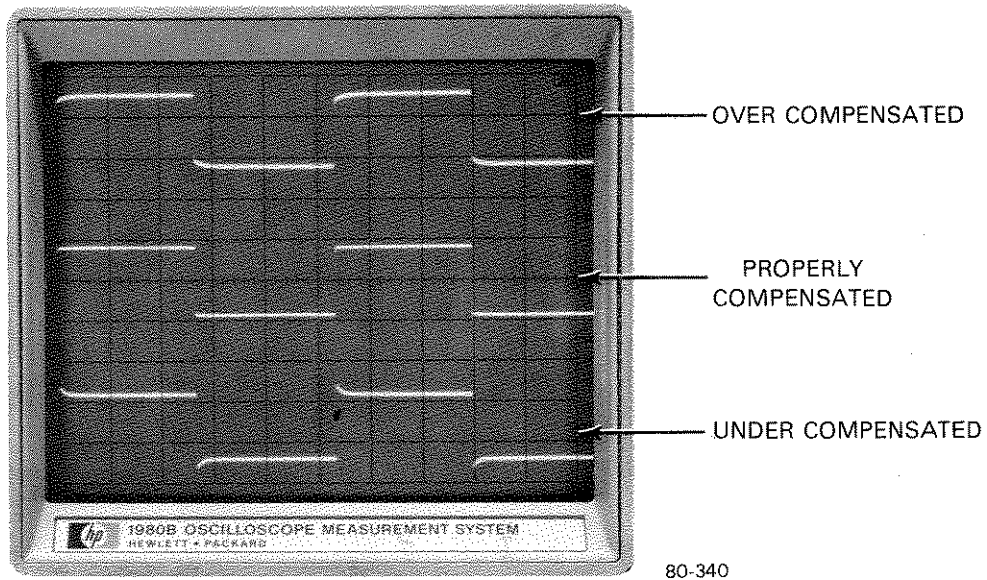

Figure 3-16. Divider Probe Adjustment Display

required in bus data transfers are not listed. General requirements for communicating with the 1980A/B are in paragraph 3-19, Remote operation, Hewlett-Packard Interface Bus.

- * HP-IB program codes are listed in ASCII code. Table 3-30 contains conversions to other commonly used codes.
- * The notation conventions used to describe HP-IB codes are defined in paragraph 3-56, Notation Conventions and Definitions.

Advisory Messages

Description The instrument generates advisory messages to indicate HP-IB syntax errors, incorrect key entries, and special operating information. The messages are displayed on the CRT in inverse video. They can also be reported via the HP-IB. The advisories can be disabled if desired.

Table 3-7 lists all advisory messages and describes the conditions which cause them. Figure 3-17 contains a typical advisory message display.

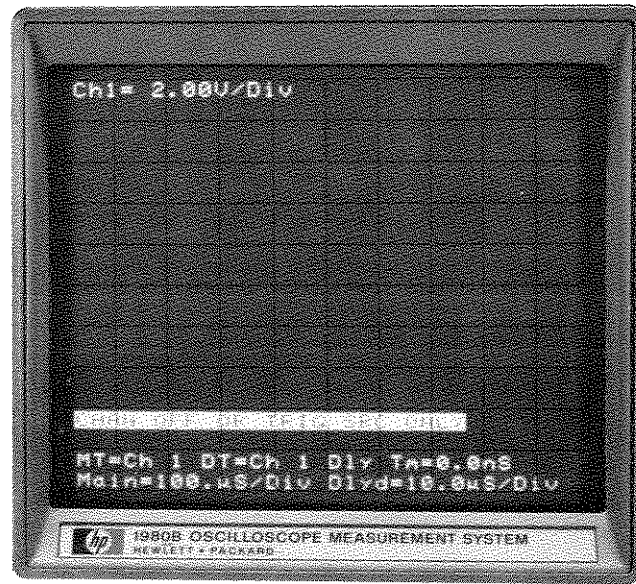

80-339

Figure 3-17. Typical Advisory Message Display

Procedure Disable advisory messages with the key sequence:

```

OPTION 2 CHAR CALIBRATE & UTILITIES
MENU: INTEN
4 UTILITIES
4 ADVISORIES OFF
    
```

Enable advisory messages with the key sequence:

```

OPTION 2 CHAR CALIBRATE & UTILITIES
MENU: INTEN
4 UTILITIES
3 CHAR ADVISORIES ON
MENU: OFF
    
```



Program Codes

Enable or disable the advisory message display:

AV<state>

```

state ::=
0 disable advisories
1 enable advisories
    
```

Advisory Messages (Cont'd)

Example Disable the advisory message display.

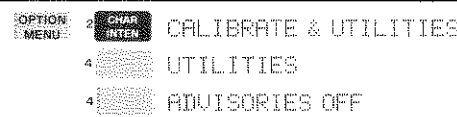
LOCAL (keys)	 <p style="font-size: small; margin: 0;"> OPTION MENU 2 CHAR INTEN 4 4 4 4 </p>
REMOTE (codes)	<div style="display: flex; justify-content: space-between; align-items: center;"> identifier AVO <CR> <LF> state EOS </div>

Indication When the advisory display is enabled or disabled from the front-panel, the 1980A/B accepts the key entry and then exits the UTILITIES menu.

Comments At power-on, the advisories are enabled as a default condition.

In remote operation, advisory messages can be programmed to cause a service request. This capability is independent of whether the advisory display is enabled or disabled. For more information, refer to the "Service Request Condition" Detailed Operating Instruction.

The "Instrument Status" Detailed Operating Instruction explains how to read the advisory code via the HP-IB. Table 3-7 includes the HP-IB codes for the advisory messages.

The code for the HP-IB SYNTAX ERROR advisory can not be reported via HP-IB nor can this advisory cause a service request. HP-IB syntax errors are handled separately, refer to the "HP-IB Syntax Errors" Detailed Operating Instruction for more information.





Related Sections

- Character Generator
- Error Messages
- HP-IB Status Advisory
- HP-IB Syntax Errors
- Instrument Status
- Service Request Condition



Advisory Messages (Cont'd)

Table 3-7. Advisory Message Description (Page 1 of 2)



Advisory Message Description	HP-IB Code
OPTION INSTALLED HAS NO MENU — there is no menu display for the option selected. For more information, refer to the operating information supplied with the option.	1
CHANNEL IS OFF — the deflection factor, polarity, or coupling of a vertical channel cannot be changed from the front-panel while the channel is off.	2
DLY'D SWEEP IS OFF — the delayed sweep speed, trigger level, trigger qualifiers, sweep mode, and delay cannot be changed from the front-panel while the delayed sweep is off. Instrument must be in V vs T mode and in intensified, delayed, or dual horizontal mode.	3
DLY'D SWEEP IN AUTO — although the trigger qualifiers for the delayed sweep may be changed while it is in auto-sweep mode, this sweep mode does not require a trigger signal.	4
KEY DISABLED — the key pressed was not accepted, either the function is not allowed or there is no current function assignment.	5
CHARACTER GENERATOR OFF — character intensity cannot be changed when the characters are not displayed.	6
CHAN OFF OR TRIG SOURCE ONLY — the vertical position cannot be adjusted when the channel is off or only being used as a trigger source.	7
TO CHANGE INT SRC (SEL CHAN) — select the internal trigger source by pressing  or  .	8
SCOPE UNDER REMOTE CONTROL — the instrument is in Remote mode; all keys except  , and  are disabled.	9
SCOPE NOT IN V VS T MODE — key pressed is enabled only when the instrument is in V vs T mode.	10
HP-IB SYNTAX ERROR — an HP-IB syntax error occurred.	*
SCOPE NOT IN DUAL MODE — dual separation can only be adjusted if the instrument is in dual horizontal mode.	12
CONTROL KNOB IN HOLD — Control Knob is not assigned to any function. Select the desired variable function by pressing the corresponding key.	13

* The HP-IB SYNTAX ERROR advisory is not reported via HP-IOB. Refer to Comments section of this instruction.

Advisory Messages (Cont'd)



Table 3-7. Advisory Message Description (Page 2 of 2)

Advisory Message Description	HP-IB Code
<p>SELECT VERT POSN OR DELAY — to enter ΔV or ΔT mode, first press  (channel 1 or 2) or , then press .</p>	14
<p>SIGNAL NOT FOUND — no signal is detected within the frequency or amplitude range for autoscope.</p>	15
<p>CAL MEMORY PROTECTED — the rear-panel calibration protection switch is set to PROTECTED, calibration is not possible.</p>	16
<p>CAL MEMORY NOT PROTECTED — the rear-panel calibration protection switch is set to NOT PROTECTED. Set it to PROTECTED before using the 1980A/B.</p>	17
<p>ΔT ONLY IN AUTO SW AFTER DLY — ΔT measurements can only be made when delayed sweep is in auto-sweep mode.</p>	18
<p>LONG HOLDOFF BY SLOW MAIN SW — main sweep speed is much slower than delayed; may cause viewing problems.</p>	19
<p>LONG HOLDOFF BY SLOW DLY'D SW — delayed sweep speed is much slower than main; may cause viewing problems.</p>	20
<p>INTEN'D TRACE OFF SCREEN — the delay time is greater than ten times the main sweep speed. The intensified marker is beyond the main sweep window.</p>	21
<p>1/ΔT IN ΔT MODE ONLY — only a ΔT value can be expressed in terms of frequency. Select ΔT mode.</p>	22
<p>PASSED TEST — the Confidence Test, RAM Test, or ROM Checksum found no errors.</p>	24
<p>FAILED TEST — the Confidence Test, RAM Test or ROM Checksum found an error. The instrument should be checked by qualified service personnel.</p>	25

Autoscope

Description Autoscope finds the amplitude and period of signal inputs and displays them on the CRT. For many waveforms, it provides a one keystroke setup of the 1980A/B. Autoscope is optimized for repetitive input waveforms with the following characteristics:

- frequency 50 Hz to 100 MHz
- amplitude 20 mV to maximum input rating

Autoscope executes the following general procedure:

Preset the conditions listed in table 3-8.

Test signal amplitude at each vertical input. If a signal is found, adjust channel delection factor for approximately 3 divisions of display. If no signals are found, display advisory and end routine.

Turn off channels with no signal input.

Select signal from lowest numbered channel as trigger source for main and delayed sweeps. Set trigger level to ± 0.5 divisions.

Determine period of trigger source and set main sweep speed for approximately 2 cycles of display. Set delayed sweep speed to 0.1 of main value.

Display input waveforms and return control to front-panel or HP-IB operator.

With selective autoscope, the operator can define which channels are to be autoranged. In addition, selective autoscope preserves coupling, trigger source, and trigger level selections. Table 3-8 describes which functions are preset and which are preserved by selective autoscope.

Procedure To execute autoscope, press .

To execute selective autoscope, press .



Program Codes

Execute autoscope:

AS

Execute selective autoscope:

SA

Autoscope (Cont'd)

Example Execute Autoscope.

LOCAL (keys)	
REMOTE (codes)	identifier ————— AS <CR> <<LF> ————— EOS

Indication As the 1980A/B is autoranging deflection factor and sweep speed for each input channel, the signal waveform is visible on the CRT. At completion of autoscope, all input signals greater than 10mV are displayed.

Comments Selective autoscope defaults to full autoscope execution if any of the following conditions are detected:

- * 1980A/B not in V vs T mode
- * No vertical channels on
- * 1 + 2 vertical mode selected

If no input signals are found when autoscope is executed, these additional presets are made:

- * Trigger source (main and delayed) = channel 1
- * Main sweep speed = 50.0 μ sec/div
- * Delayed sweep speed = 5.00 μ sec/div
- * Vertical deflection factor (all channels) = 2.00 V/div

In remote operation, customized autoscope routines (controller driven) can be implemented using the trigger flag. Refer to the "Trigger Flag" Detailed Operating Instruction.

Related Sections Reading Values Via HP-IB
 Trigger Flag

Autoscope (Cont'd)

Table 3-8. Autoscope and Selective Autoscope Preset Conditions

Instrument Function	After Autoscope	After Selective Autoscope
Advisory Messages	no change	no change
Bandwidth Limit	off	no change
Calibrator Level	1 V p-p	1 V p-p
Control Knob Assignment	main sweep speed	main sweep speed
Character Generator	on	on
Delay	0 sec, coarse	0 sec, coarse
Delta Time	off	off
Delta Volts		
channel 1	off	off
channel 2	off	off
Horizontal Position	0.00 div, coarse	0.00 div, coarse
Horizontal Mode	main	main
HP-IB status advisory	no change	no change
Intensity, Characters	70%, coarse	no change
Intensity, Panel Lamps	90%, coarse	no change
Intensity, Trace	25%, coarse	25%, coarse
Scope Mode	V vs T	V vs T
Separation, Dual	-3.0 div	-3.0 div
Soft Key Menus	no change	no change
Sweep Mode, Delayed	auto-sweep	no change
Sweep Mode, Main	auto	no change
Sweep Speed, Delayed	autoranged	autoranged
Sweep Speed, Main	autoranged	autoranged
Text Display	no change	no change
Trigger, Delayed		
source	internal, selected	no change
slope	positive	no change
level, internal	0.5 div	set to main level
level, external ($\div 10$ or $\div 1$)	0.5 V	refer to comments
coupling	AC	no change
Trigger, Main		
source	internal, selected	no change
slope	positive	no change
level, internal	0.5 div	no change
level, external ($\div 10$ or $\div 1$)	0.5 V	no change
level, line	0.5 V	no change
coupling	AC	no change
Trigger View	off	no change
Vertical Coupling	AC	no change
Vertical Deflection	autoranged	autoranged
Vertical Mode	selected	no change
Vertical Position	selected	no change

Bandwidth Limit

Description Bandwidth limit changes the roll-off of the vertical signal path. It is used to filter signals displayed on the vertical axis when the 1980A/B is in either V vs T or 1 vs 2 mode. Bandwidth limit does not affect internal trigger signals.

Vertical Bandwidth Characteristics

limit off -3 dB at 100 MHz
 limit on -3 dB at 20 MHz

Procedure To toggle bandwidth limit on or off, press .



Program Codes

Turn bandwidth limit on or off:

BW <state>

state ::= 0 bandwidth limit off
 1 bandwidth limit on

Example Turn on bandwidth limit.

LOCAL (keys)	
REMOTE (codes)	identifier ——— BW1 <CR><LF> ——— EOS state

Indication When bandwidth limit is on,  is lighted.

Related Sections Scope Mode
 Trigger, Delayed Sweep
 Trigger, Main Sweep
 Vertical Coupling
 Vertical Deflection Factor



Calibrator Level (Cont'd)

Comments The calibrator output amplitude is reset to its default value of 1V p-p by the following:

- * Power-on
- * Executing autoscope
- * Executing preset (HP-IB "IN")
- * ROM Checksum
- * RAM Test
- * Confidence Test

Calibrator level cannot be stored in the Save/Recall registers nor is it changed when an instrument state is recalled.

Related Sections Probe Compensation (paragraph 3-50)

Character Generator

Description The character generator displays the CRT readout, advisory messages, and soft key menus. It can also be programmed via HP-IB for special text displays. This instruction describes the CRT readout, and some general considerations about using the character generator.

Primary vertical and horizontal parameter values and the trigger source selections are displayed by the CRT readout. When the Control Knob is assigned to one of these functions, the function name is displayed in inverse video. Figure 3-18 contains a typical readout display.

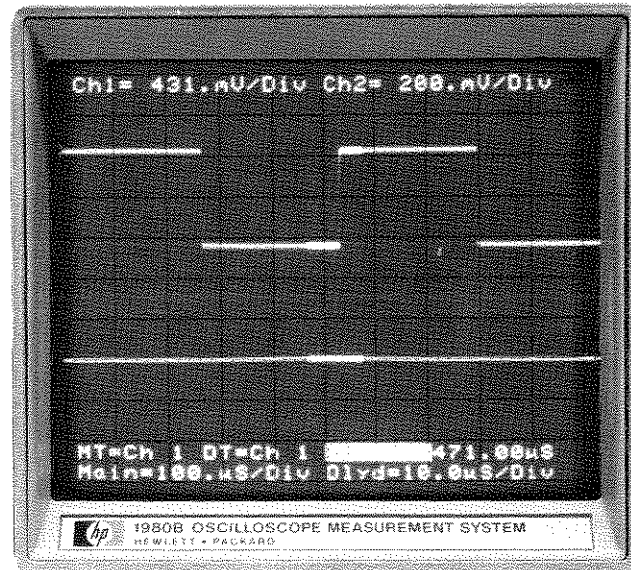

Figure 3-18. The 1980A/B CRT Readout

The character generator writes all characters during the main and delayed sweeps. In other words, characters are multiplexed with the traces. Although this technique provides a high quality character display, at some sweep speeds it may interfere with the trace display. For example, press the key sequence **OPTION** **1** **ENTER** **SECS** **MENU** **1** **ENTER** **DIV.** and change main sweep speed to approximately 6 msec/div with the Control Knob. The "holes" in the traces are caused by the character generator. Press **3** **CHAR** **ON/OFF**, and the "holes" disappear.

The following steps can be taken if the character generator interferes with measurements:

- * Reduce the number of displayed traces to fewest required for making the measurement.
- * Select chop vertical display mode.
- * Turn off the character generator, use only the LED readout for parameter value display.

Procedure To toggle the character generator on or off, press **3** **CHAR** **ON/OFF**. This key controls all characters displayed except the advisory messages and the HP-IB status advisory.

Character Generator (Cont'd)



Program Codes

Toggle the character generator on or off:

SK3

Turn only the CRT readout on or off:

CG <state>

state::= **0** CRT readout off
 1 CRT readout on

Example

Turn off the CRT readout.

LOCAL (keys)	CHAR ON/OFF
REMOTE (codes)	<p style="text-align: center;"> identifier CGO <CR> <LF> EOS </p> <p style="text-align: center;"> state </p>

Comments

In local or remote operation, if the CRT readout is turned off with CHAR ON/OFF or the HP-IB program code "SK3", the following conditions turn the readout on again:

- * Power-on
- * Executing autoscope
- * Executing selective autoscope
- * Calling OPTION MENU

In local or remote operation, if the CRT readout is turned off with the HP-IB program code "CGO", calling OPTION MENU or cycling the LINE switch turns the readout on again.

If the CRT readout is disabled via HP-IB with the program code "CGO", CHAR ON/OFF and the program code "SK3" only toggle the HP-IB text field on or off.

The state of the character generator can be established via the HP-IB by initializing the 1980A/B with the "IN" program code.

Related Sections

- Advisory Messages
- Control Knob
- HP-IB Status Advisory
- Initialize
- Intensity, Characters and Lamps
- Soft Key Menus
- Text Display

Control Knob

Description The Control Knob is used to change the value of variable function parameters such as sweep speed, deflection factor, trigger level, and delay. The knob is assigned to a variable function by pressing the corresponding key. As the knob is rotated, the value is immediately changed.

The Control Knob is a stepping control; either coarse or fine step resolution can be selected. In coarse, the speed of knob rotation affects the step size so that changes can be quickly made. Fine provides vernier-like control where step size is set for maximum resolution.

Accidental changes to parameters can be prevented by selecting hold mode. In hold, the knob is not assigned to any variable function.

The Control Knob can also be assigned to variable functions via the HP-IB. In this special case, the knob is enabled for local operation, even if the 1980A/B is in remote mode. This allows the selected function to be adjusted from the front-panel, while all other keys and functions remain in remote.

Procedure To assign the Control Knob to a function, press the corresponding variable function key:

		trace intensity
		panel intensity
		character intensity
	(ch 1 or 2)	deflection factor
	(ch 1 or 2)	vertical position
	(main or dly'd)	sweep speed
	(main or dly'd)	trigger level
		horizontal position
		dual separation
		delay (time or digital)
		delay time, numerical

Toggle Control Knob between fine and coarse step resolution by pressing

To select hold mode, press . Exit hold by assigning the Control Knob to a variable function.

Control Knob (Cont'd)



Program Codes

Assign the Control Knob and set step resolution:

RC <code>[, <step>]

- | | |
|----------|-----------------------------------------------------------------------------------------------------------------------------------------------------------------------------------------------------------------------------------------------------------------------------------------------------------------------------------------------------------------------------------------------------------------------------------------------------------------------------------------------------------------------------------------------------------------------------------------------------|
| code ::= | <ul style="list-style-type: none"> 0 hold 1 channel 1 deflection factor 2 channel 2 deflection factor 3 main sweep speed 4 delayed sweep speed 5 channel 1 position 6 channel 2 position 7 channel 1 position 8 channel 2 position 9 dual separation 10 horizontal position 11 main trigger level 12 delayed trigger level 13 delay 14 delay 15 delay 16 trace intensity 17 character intensity 18 panel intensity |
| step ::= | <ul style="list-style-type: none"> 0 coarse 1 fine |

To assign the Control Knob to delay in the numerical entry mode, first send the program code: **KY7,41** — then send **RC13,0** or **RC13,1** to select step resolution. Refer to the "Key" Detailed Operating Instruction for more information about the "KY" command.

The program codes for assigning the Control Knob to ΔT and ΔV are described in the "Delta Time" and "Delta Volts" Detailed Operating Instructions, respectively.

Example

Assign Control Knob to channel 1 deflection factor, coarse step resolution.

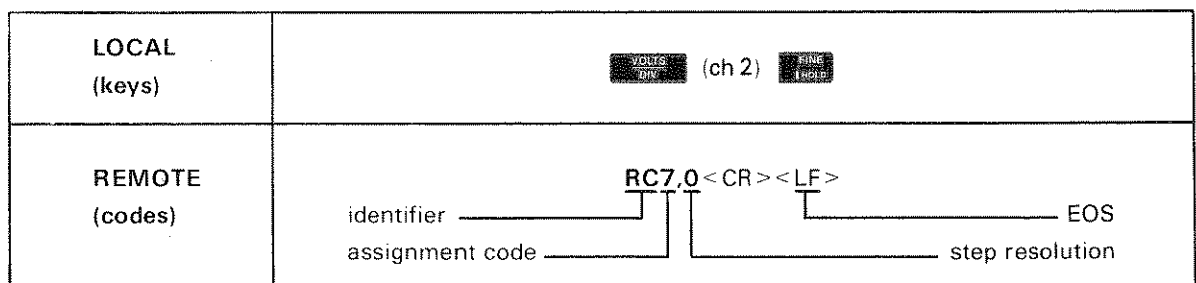

Control Knob (Cont'd)

Indication Control Knob assignment is indicated by lighting the corresponding variable function key. Also, the LED readout displays the parameter value of the function.

The LED readout displays H o L d to indicate hold mode is selected. If the Control Knob is rotated while in hold, the advisory CONTROL KNOB IN HOLD is displayed.

When the Control Knob is assigned to a variable function displayed by the CRT readout, the function name is displayed in inverse video.

 lights to indicate that fine is selected.

Comments The Control Knob defaults to hold mode when the 1980A/B makes the remote-to-local transition.

Executing autoscope or selective autoscope assigns the Control Knob to main sweep speed. If the 1980A/B is in remote mode, the Control Knob is enabled as though the program code **RC3,0** was sent.

Executing preset (HP-IB "IN") in remote or local mode assigns the Control Knob to trace intensity. If the 1980A/B is in remote mode, the Control Knob is enabled as though the program code **RC16,0** was sent.

Control Knob step resolution for a variable function may also be changed by the following:

- * Executing autoscope
- * Executing selective autoscope
- * Executing preset (HP-IB "IN")
- * Recalling settings from Save/Recall registers

Related Sections

- Delay
- Delta Time
- Delta Volts
- Horizontal Position
- Intensity, Character and Lamp
- Intensity, Trace
- Reading Values Via HP-IB
- Separation, Dual
- Sweep Mode, Delayed
- Sweep Mode, Main
- Sweep Speed, Delayed
- Sweep Speed, Main
- Trigger, Delayed
- Trigger, Main

Delay

Description The delay from the main sweep trigger until the start of the delayed sweep is expressed in terms of time or trigger events, depending upon which delayed sweep mode is in effect. This instruction explains how to set the delay factor for each of the delayed modes.

There are two basic modes for delay time entry from the front-panel of the 1980A/B. Normally the delay time parameter step resolution is determined by the sweep speed of the displayed timebases. This is usually the best mode of entry when making measurements on waveforms displayed on screen because the step resolution is proportioned to the displayed waveform. A second basis for delay time step resolution is provided by numerical entry mode. This mode allows specific delay values to be quickly entered. Table 3-9 describes the step resolutions available for delay time entry.

Delay Characteristics

delay time

range 0 to 9.999 999 999 9 sec

resolution

front-panel 5 digits, 100 psec minimum
(refer to table 3-9)

HP-IB 100 psec

accuracy delay time accuracy
depends upon delayed sweep
speed value and delay time
as described in table 3-10.

delay jitter 0.002% of delay time

events delay

range 0 to 99 999 999 events

resolution 1 event

maximum rep rate 15 MHz with 50% duty cycle

Table 3-9. Delay Time Step Resolution (front-panel)

Entry Mode	Horizontal Mode	Coarse Step Resolution	Fine Step Resolution
Numerical	all modes	Second most sig. digit	Least sig. digit
Normal	intensified	0.03 × main sweep speed	0.0001 × main sweep speed
Normal	delayed	0.03 × delayed sweep speed	0.0001 × delayed sweep speed
Normal	dual	0.03 × main sweep speed	0.03 × delayed sweep speed

Delay (Cont'd)

Table 3-10. Delay Time Accuracy*

Delay Value	Delayed Sweep Speed Value	
	5 to 9.99 nsec/div	≥ 10 nsec/div
< 200 μsec	±(2 nsec + 0.1% of reading)	±(2 nsec + 0.1% delay value + 10% of sweep speed value)
≥ 200 μsec	±(0.05% of delay value)	±(0.05% of delay value + 10% of sweep speed value)

* Guaranteed within 60 minutes after execution of Delay Time Self-cal at constant ambient temperature.

Procedure To enter a delay value, press  and rotate the Control Knob.

To enter delay time values using the numerical entry mode, press .

Press  to select step resolution for delay time (numerical or normal entry mode), or digital delay entries.

Zero the delay value by pressing .



Program Codes

Enter delay time value when the delayed sweep is in auto or triggered sweep mode:

DY <value >

value ::= exponential
 [+]{d.dd|dd.d|ddd}{d...}{e|E}{-[d]|+0}
 100 psec to 9.999 999 999 9 sec
 least significant nonzero digit must be ≥ 100 psec
 most significant digit must be ≤ 9sec

Enter events delay value when delayed sweep is in digital delay mode:

DD <value >

value ::= integer
 [d...]d
 † 7 digits maximum
 0 to 99 999 999 events

Delay (Cont'd)

Example Enter delay time value of 20 μ sec using numeric entry mode.

<p>LOCAL (keys)</p>	
<p>REMOTE (codes)</p>	<p>identifier <u> </u> <u>DY20.0e-06</u> <CR> <LF> <u> </u> EOS</p> <p style="text-align: center;"> delay value</p>

Indication When the Control Knob is assigned to delay,  is lighted and the delay value is displayed in the LED readout. Delay time values are displayed by the readout as exponential numbers, digital delay values are displayed as integers.

Comments It is a syntax error if a time or events delay value is entered via HP-IB when the delayed sweep is not in the corresponding delay mode. This error, however, is not trapped. Always ensure the proper delay mode is selected before entering delay values. Refer to the "Sweep Mode, Delayed" Detailed Operating Instruction for more information about selecting delayed sweep mode.

If a delay time value is entered via HP-IB when numerical entry mode with coarse step resolution is selected, the 1980A/B only accepts two digits of the delay time value. If a delay time value with more than two digits is entered, the value is truncated to two digits. To avoid this condition, ensure the delay time function is either in normal entry mode or numerical entry mode, fine step resolution.

In triggered or digital delay delayed sweep modes, the setup time of the delayed trigger circuit must be taken into consideration if delayed sweep is to be triggered on the same pulse edge as main. Delayed trigger events cannot be detected until approximately 70 nsec after main trigger.

- Related Sections**
- Control Knob
 - Delay Time Self-cal (paragraph 3-49)
 - Delta Time
 - Sweep Mode, Delayed
 - Sweep Mode, Main
 - Trigger Flag

Delta Time

Description ΔT provides a convenient means for making time interval or frequency measurements from the front-panel. It is an extension of the delay time function. ΔT allows a zero time reference to be set anywhere within the delay time range. Then as delay time is incremented or decremented, the 1980A/B displays a direct readout of the time interval between the zero reference and the present delay value.

Delta Time Characteristics

range	0 sec — Tzero to 9.999 999 9 sec — Tzero
resolution	
front-panel	5 digits, 100 psec minimum (refer to table 3-9)
HP-IB	100 psec
accuracy	delta time accuracy is the same as delay time, it depends upon delayed sweep speed value and delay time as described in table 3-10.
delay jitter	0.002% of delay time

Procedure To select ΔT mode, press  while the Control Knob is assigned to delay time. If numerical entry mode is selected, numerical ΔT mode is selected with .

When the Control Knob is assigned to ΔT , the 0.0 nsec reference point is set by pressing .

Select Control Knob step resolution with .

To toggle the ΔT display between units of time and units of frequency, press .

ΔT mode can be turned off by pressing  while the Control Knob is assigned to ΔT .



Program Codes

Turn ΔT mode on or off, set the zero reference point, and assign the Control Knob to ΔT :

DZ <mode>

- mode ::= 0 ΔT off
- 1 ΔT on, zeroed, Control Knob assigned

Select Control Knob resolution:

RC13, <step>

- step ::= 0 coarse
- 1 fine

Delta Time (Cont'd)

Example Turn on ΔT and set the zero reference point at a delay value of 20 μsec from main sweep trigger.

<p>LOCAL (keys)</p>	
<p>REMOTE (codes)</p>	<p style="text-align: center;">DY20.0e-6;DZ1 <CR><LF></p> <p>identifier ———— delay value ———— identifier ———— </p> <p style="text-align: right;">EOS mode ———— </p>

Indication When ΔT mode is on, the LED and CRT readouts display the ΔT value instead of delay. The LED readout displays 0.0-9 when ΔT is zeroed.

Comments For specified accuracy, the Delay Time Self-cal should be executed within one hour before ΔT measurements are made.

Although the "DZ" command assigns the Control Knob to ΔT , it does not select numerical or normal entry mode. The last selected delay time entry mode determines the ΔT entry mode.

If sweep speeds, sweep modes, trigger levels, or main trigger conditions are changed (or the corresponding keys pressed), ΔT mode is turned off.

When ΔT is first turned on from the front-panel or via the HP-IB, ΔT is expressed in terms of time.

- Related Sections**
- Control Knob
 - Delay
 - Delay Time Self-cal (paragraph 3-49)
 - Horizontal Mode
 - Reading Values Via HP-IB
 - Sweep Mode, Delayed
 - Sweep Speed, Delayed
 - Sweep Speed, Main
 - Trigger Flag

Delta Volts

Description ΔV provides a convenient means of measuring voltage using the Control Knob. ΔV is a special operating mode of the vertical position variable function in which channel deflection factor is multiplied by change in vertical position. A zero vertical reference point can be set anywhere within the vertical position range. Then, as vertical position is incremented or decremented, the 1980A/B displays a direct reading of the voltage interval between the zero reference and the present trace position. ΔV measurements can be made with both channel 1 and 2 in either V vs T or 1 vs 2 scope modes.

Delta Volts Characteristics (Channel 1 or 2)

range ± 15 times the channel deflection factor
 resolution 0.02 times channel deflection factor
 accuracy $\pm 4\%$ for a position change ≤ 10 div

Procedure Select ΔV mode for a given channel and set the zero reference point by pressing  while the Control Knob is assigned to that channel's vertical position variable function.

While the Control Knob is assigned to channel 1 or 2 ΔV , pressing  turns off ΔV mode for that channel.

Select step resolution by pressing .



Program Codes

Turn on ΔV mode for channel 1 or 2 and assign Control Knob:

DV <channel>, <state>

channel ::= 1 channel 1
 2 channel 2

state ::= 0 ΔV off
 1 ΔV on, zeroed, Control Knob assigned

Select Control Knob step resolution:

RC <channel>|<step>]

channel ::= 5 channel 1
 6 channel 2

step ::= 0 coarse
 1 fine

Delta Volts (Cont'd)

Example Turn on channel 1 ΔV .

<p>LOCAL (keys)</p>	
<p>REMOTE (codes)</p>	<p style="text-align: center;"> DV1,1 <CR><LF> identifier ——— channel ——— state ——— EOS ——— </p>

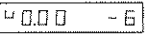
Indication When ΔV is on for a channel, the LED and CRT readouts display the ΔV value instead of deflection factor. The LED readout displays  when ΔV is zeroed.

Comments If channel deflection factor is changed after ΔV mode is selected, ΔV is turned off.

- Related** Control Knob
- Sections** Reading Values Via HP-IB
 Scope Mode
 Vertical Mode
 Vertical Deflection Factor
 Vertical Position

Error Messages

Description If the 1980A/B detects an internal hardware error, an error message is displayed in the LED readout. The error message is primarily meant as a diagnostic aid; it indicates a failure that requires the attention of qualified service personnel. Table 3-11 lists the error conditions that can be detected.

The instrument can be programmed to send the Require Service message when an error condition is detected. The condition can also be read by the system controller, refer to the "Instrument Status" Detailed Operating Instruction. Table 3-11 includes the HP-IB codes for the various error conditions.

Indication When an error is detected, the LED readout displays an error message, such as: Err -34.

Comments If an error occurs during the balance self-cal, RAM test, ROM checksum, or Confidence Test, the error message is displayed briefly in the LED readout. Then the procedure terminates and displays `FAILED TEST` on the CRT.

If a cal factor or horizontal word output error occurs, the error message is displayed in the LED readout until any key except FIND
BEAM is pressed.

The HP-IB code "25" is sent for many of the error conditions. It is the code for the advisory `FAILED TEST`, which is displayed on the CRT when an error is detected during any of the procedures described in paragraph 3-44, Operator's Checks.

Related Sections

- Instrument Status
- Remote Operation (paragraph 3-21)
- Operator's Checks (paragraph 3-44)
- Power-on Sequence and Default Conditions
- Service Request Condition

Error Messages (Cont'd)



Table 3-11. Hardware Error Codes

LED code	HP-IB Code	Error Description
Err -0	25	ROM 0 Failed checksum
Err -2	25	ROM 2 Failed checksum
Err -4	25	ROM 4 Failed checksum
Err -6	25	ROM 6 Failed checksum
Err -8	25	ROM 8 Failed checksum
Err -10	25	ROM 10 Failed checksum
Err -12	25	ROM 12 Failed checksum
Err -14	25	ROM 14 Failed checksum
Err -16	25	ROM 16 Failed checksum
Err -18	25	ROM 18 Failed checksum
Err -20	25	ROM 20 Failed checksum
Err -22	25	ROM 22 Failed checksum
Err -24	25	ROM 24 Failed checksum
Err -26	25	ROM 26 Failed checksum
Err -28	25	ROM 28 Failed checksum
Err -30	25	ROM 30 Failed checksum
Err -31	25	Confidence-test vertical channel error
Err -32	25	Confidence-test horizontal range error
Err -33	25	Confidence-test 10 V signal not found
Err -34	25	Confidence-test 1 V signal not found
Err -35	25	Confidence-test 0.1 V signal not found
Err -36	25	Confidence-test 0.02 V signal not found
Err 40	66	1980A/B cal factor checksum error
Err 51	77	Channel 1 failed autobalance
Err 52	78	Channel 2 failed autobalance
Err -60	25	Scratch RAM (U16) failed
Err -61	25	Nonvolatile RAM (U42, 43) failed
Err -62	25	Character RAM (U32, 33) failed
Err -64	25	Feature RAM (U34, 36) failed
Err -66	25	Save/Recall RAM (U35, 37) failed
Err 72	98	Horizontal Word output failed

Horizontal Mode

Description In V vs T scope mode, four horizontal modes are available. The modes are: Main, main intensified, delayed, and dual. Main displays vertical inputs with respect to the main timebase. Main intensified displays the vertical inputs with respect to the main timebase, and intensifies the portion of the trace that occurs during delayed sweep. Delayed displays the vertical inputs with respect to the delayed timebase. Dual displays both the main intensified and the delayed sweep traces using the selected vertical mode (alternate or chop).

In main mode, only the main timebase is on. The delayed timebase and trigger controls are not enabled.





In main intensified, delayed, and dual modes the main and delayed timebases are on. The main and delayed sweeps are dependent on each other in two ways:

- * Delayed sweep cannot begin until main sweep has been triggered.
- * Main sweep cannot repeat until delayed sweep is completed.

Unlike traditional scopes, the 1980A/B allows main and delayed sweep speeds to be set independently. Also, the delay until start of delayed sweep is totally independent of the main sweep speed. This allows considerable versatility in waveform measurement and viewing. For example, the first and last events of a block of serial data can be displayed simultaneously at any sweep speed by triggering main at the first event and delaying delayed sweep until the last event.

For more information about using the main and delayed sweeps, refer to the sections listed at the end of this instruction.

Procedure Select horizontal mode with the following keys:

	main sweep
	main sweep intensified by delayed
	delayed sweep
	dual sweep



Program codes

Select horizontal mode:

HM < mode >

mode::=	1 main
	2 main intensified
	3 delayed
	4 dual

Horizontal Position

Description In V vs T mode, the horizontal position of the displayed waveforms can be adjusted for viewing convenience. When horizontal position is zero, the sweeps begin at the leftmost graticule line.

Horizontal Position Characteristics

range ±6.00 div
 resolution 0.02 div

Procedure To change horizontal position, press  and adjust with Control Knob. Resolution is the same in coarse and fine. In coarse, step size is a function of speed of rotation of the Control Knob.





Program Codes

Enter horizontal position value:

HP <value>

value ::= decimal
 [+ | - | <SP>] [d] d . d [d]
 -6.00 to +6.00 div
 value must be multiple of 0.02 div

Example Change horizontal position setting to +2.44.

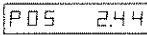
LOCAL (keys)	  
REMOTE (codes)	<p>identifier ——— HP + 2.44 <CR> <LF> ——— EOS</p> <p style="margin-left: 100px;"> </p> <p style="margin-left: 100px;">value</p>

Indication When Control Knob is assigned to horizontal position,  is lighted and the position value is displayed in the LED readout.

Related Sections Control Knob
 Reading Values Via HP-IB



HP-IB Address

Description The HP-IB addressing mode and address can be displayed and changed from the front-panel using soft key menus.

Procedure To check the current address or addressing mode, call the HP-IB ADDRESS MODE menu. Press 5 19842A HP-IB.

Press 6 CHANGE ADDRESS MODE to step the 1980A/B through the three addressing modes.

When the 1980A/B is set to addressable (ADDRESS =<dd>) mode, the address value can be changed by pressing 3 INCREMENT or 4 DECREMENT.

Press to return the soft keys to their normal functions.

Example Check the HP-IB addressing mode and address.

LOCAL (keys)	5 1980A/B HP-IB then exit the menu with
-------------------------	---------------------------------------------

Indication The following information is displayed in the HP-IB ADDRESS MODE menu to indicate the current addressing mode and address:

ADDRESS=<dd> - indicates instrument is addressable. <dd> is the instrument talk and listen address.

LISTEN ONLY - indicates listen-only mode selected.

TALK ONLY - indicates talk-only mode is selected.

When listen-only mode is selected, the HP-IB status advisory displays HP-IB: L .

When talk-only mode is selected, the HP-IB status advisory displays HP-IB: T .

Comments Talk-only mode is not supported by the standard 1980A/B.

Calling the HP-IB ADDRESS MODE menu resets all HP-IB parameters, except the address value and addressing mode, to the states described in the "Power-on Default Conditions" Detailed Operating Instruction.

Related Sections HP-IB Status Advisory
 Power-on Sequence and Default Conditions
 Remote Operation (paragraph 3-21)



HP-IB Status Advisory

Description The HP-IB status advisory displays basic HP-IB status information on the CRT. The advisory indicates when the instrument is in remote mode; is addressed to talk or listen; or if it has issued the Require Service message. If none of these conditions are in effect, the advisory is not displayed. The status advisory can be disabled via the HP-IB.

Table 3-12. Symbols Used in HP-IB Status Advisory

Advisory Symbol	HP-IB Status Indication
R	Switched to remote mode
L	Addressed to listen
T	Addressed to talk
S	Issued the Require Service message

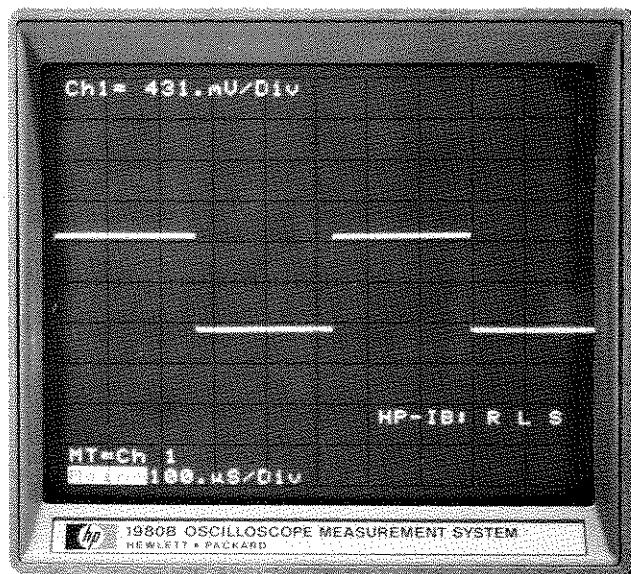

Figure 3-19. The HP-IB Status Advisory



Program Codes

Enable or disable the HP-IB status advisory:

BA <state>

- state ::= 0 status advisory off
- 1 status advisory on



HP-IB Status Advisory (Cont'd)

Example Turn off the status advisory.

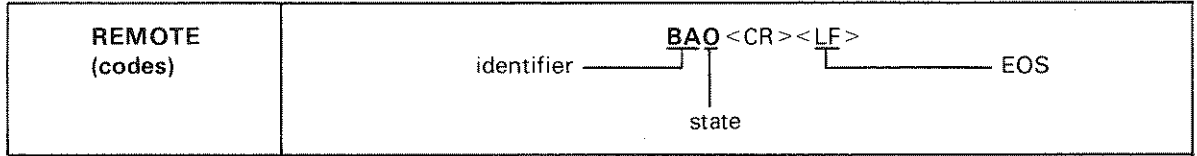

Comments In listen-only or talk-only addressing modes, status advisory is enabled. HP-IB: L and HP-IB: T are displayed, respectively.

- Related** Character Generator
- Sections** HP-IB Address
- Intensity, Characters and Lamps



HP-IB Syntax Errors

Description When an error in HP-IB message syntax is detected by the 1980A/B, it aborts the execution of the Data message. Program codes up to the error are executed, those following the error are ignored. For more specific information on message execution, refer to Receiving the Data Message, paragraph 3-30.

The instrument can be programmed to issue the Require Service message in response to syntax errors. The type of error can then be determined by reading the error code via the HP-IB. Table 3-13 lists the types of syntax errors the instrument detects, and their corresponding HP-IB codes. The "Service Request Condition" and "Instrument Status" Detailed Operating Instructions explain how to detect errors and read their codes.

Table 3-13. HP-IB Syntax Errors

HP-IB Code	Syntax Error Description
1	Parameter out of range
2	Command not recognized
3	Missing terminator
4	Unexpected character
5	Input buffer overflow
6	Data output not specified

Indication A syntax error causes `HP-IB SYNTAX ERROR` advisory to be displayed on the CRT if advisories are enabled.



Comments If the 1980A/B is addressed to talk before the output data is specified, it outputs ASCII character "E" to complete the bus transaction. This syntax error does not cause `HP-IB SYNTAX ERROR` advisory, and does not cause the Require Service message to be sent. However, if the status qualifier for HP-IB syntax is read, the 1980A/B outputs error code 6.

Related Sections

- Advisory Messages
- Instrument Status
- Reading Values Via HP-IB
- Remote Operation (paragraph 3-21)
- Service Request Condition

Initialize

Description The 1980A/B can be initialized to a defined state using the soft keys or via the HP-IB. Table 3-14 contains a complete description of the initialized state.

Procedure To initialize the instrument, press   PRESET.





Program Codes

Execute initialize:

IN

Example Initialize the 1980A/B.

LOCAL (keys)	  PRESET
REMOTE (codes)	identifier _____ IN <CR> <LF> _____ EOS

Indication The instrument changes to the setup described in table 3-14.

Comments Initializing via the HP-IB turns off soft key menus. Therefore, it provides a known "starting point" for selecting menu functions via HP-IB.

Related Sections Soft Key Menus

Initialize (Cont'd)

Table 3-14. 1980A/B Initialized State

Instrument Function	Initialized State
Advisory Messages	no change
Bandwidth Limit	off
Calibrator Level	1 V p-p
Character Generator	on
Control Knob Assignment	trace intensity
Delay	0.0 nsec, coarse
Delta Time	off
Delta Volts	
channel 1	off
channel 2	off
Horizontal Position	0.00 div, coarse
Horizontal Mode	main-intensified
HP-IB Status Advisory	no change
Intensity, Characters	70%, coarse
Intensity, Lamps	90%, coarse
Intensity, Trace	25%, coarse
Scope Mode	V vs T
Separation, Dual	-3.00 div, coarse
Soft Key Menus	off
Sweep Mode, Delayed	auto-sweep
Sweep Mode, Main	auto
Sweep Speed, Delayed	10.0 μ sec/div, fine
Sweep Speed, Main	100 μ sec/div, coarse
Text Display	off
Trigger, Delayed	
source	channel 1
slope	positive
level, external $\div 10$	1 V, coarse
level, internal	1.00 div, coarse
coupling	AC
Trigger, Main	
source	channel 1
slope	positive
level, external $\div 10$	1 V, coarse
level, internal	1.00 div, coarse
coupling	AC
Trigger View	off
Vertical Coupling	
channel 1	AC
channel 2	AC
Vertical Deflection	
channel 1	2.00 V/div, fine
channel 2	2.00 V/div, fine
Vertical Mode	channel 1 and 2 on, auto-alternate display
Vertical Position	
channel 1	0.00 div, coarse
channel 2	-2.00 div, coarse

Instrument Status



Description The 1980A/B can issue a Require Service message on the HP-IB under one or more operator selectable conditions. Whenever the enabled condition occurs, it sets both the bit corresponding to the condition and the RQS bit (bit 6) in the Status Byte. The bits set in the Status Byte are not cleared unless the Status Byte is read (by serial polling), or the LINE switch is cycled.

If more than one enabled condition occurs before the Status Byte is read, the 1980A/B queues them, each in a separate byte, in the order in which they happened. Up to 9 conditions (Status Bytes) can be stacked in this way. The stack must be read, byte by byte, using successive serial polls. Each byte contains an RQS bit so that the instrument will issue and reissue the Request Service message until the entire stack is cleared.

For applications where the RQS interrupt is inconvenient or unnecessary, the Require Service message can be inhibited. In this mode, a single Status Byte register in the 1980A/B traps the occurrence of all of the 7 conditions. Although the instrument will not issue the Require Service message, the Status Byte may still be read by serial polling.

Supplemental information about status conditions that occur is contained in the status qualifier registers. These can be read to determine which error occurred, which key was pressed, etc. The qualifier registers can be read without reading the Status Byte message if desired.

Procedure The instrument status registers are not accessible from the front-panel.

The Status Byte is read via the serial poll sequence described in figures 3-14 and 3-15.



Program Codes

To read the status qualifiers, select the data to be output by the 1980A/B:

OQ<code>

code ::=	1	HP-IB syntax error code
	2	last key code
	3	trigger flag state
	4	advisory or error code
	5	internal option code
	6	plug-in option code

Then, address the instrument to talk and read the data.



Instrument Status (Cont'd)

Example Command the 1980A/B to output trigger flag state.

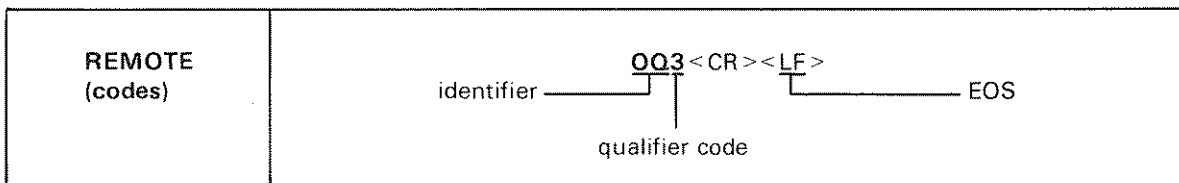

Indication If an enabled Service Request condition occurs, the HP-IB status advisory displays until the Status Byte message is cleared.

Comments The status qualifier registers contain information pertaining only to the last occurrence of the corresponding condition.

- Related Sections**
- Advisory Messages
 - Error Messages
 - HP-IB Status Advisory
 - HP-IB Syntax Errors
 - Key
 - Service Request Condition
 - Soft Key Menus
 - Trigger Flag

Intensity, Characters and Lamps

Description The brightness of the characters displayed on the CRT, and of the panel lamps (including the LED readout) can be adjusted from the front-panel or via the HP-IB. The intensities of both the characters and lamps are expressed as % of full intensity.

Procedure To change the brightness of the character display, press and adjust with the Control Knob.

To change the brightness of the panel lamps and the LED readout, press and adjust intensity with the Control Knob.



Program Codes

Enter character and lamp intensity values:

FP <char> [, <lamp>]

char ::= integer
[d] d

lamp ::= integer
[d] d

Example Set the character intensity to "80" and the lamp intensity to "85".

LOCAL (keys)	
REMOTE (codes)	<pre> identifier — FP80, 85 <CR> <LF> — EOS char intensity — — lamp intensity </pre>

Comments If character generator is on and character intensity is set to value less than 35 when OPTION MENU is called, the character intensity is preset to level 35.



If the CRT readout is off, the character intensity level can not be changed from the front-panel.

Related Sections
 Character Generator
 Control Knob
 HP-IB Status Advisory

Intensity, Trace

Description The intensity level of displayed waveforms can be adjusted over a wide range with the trace intensity variable function. This is necessary because perceived trace intensity (brightness) depends upon ambient lighting, beam writing rate, and beam repetition rate.

As an operating convenience, two values of trace intensity can be entered. One value is used in main, intensified, or dual horizontal modes and in 1 vs 2 and X-Y-Z scope modes. The other value is used only in delayed horizontal mode.

Procedure To change trace intensity, press , then adjust Control Knob for desired brightness. The trace intensity used in delayed horizontal mode () must be entered while that mode is selected.



Program Codes



Enter trace intensity values:

CI <main>[, <delayed>]

main ::= integer
[d]d

delayed ::= integer
[d]d

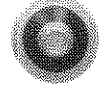
Example Set the main trace intensity to "30" and the delayed trace intensity to "45".

LOCAL (keys)	  <input type="text" value="30"/>   <input type="text" value="45"/>
REMOTE (codes)	<p>identifier ——— C130,45 <CR> <LF> ——— EOS</p> <p>main intensity ——— ——— delayed intensity</p>

Indication When the Control Knob is assigned to trace intensity,  is lighted and the LED readout displays the intensity value.

Comments For longest CRT life, use the lowest trace intensity value that provides a viewable waveform.

Related Sections Control Knob
Intensity, Characters and Lamps
Horizontal Mode

Key



Description The remote operator can simulate the pressing of front-panel keys using the key (KY) command. Although almost every function is addressable using the primary command set, the key command can be used as an alternative.

Procedure Send a series of key codes in the same order as keys would be pressed in local operation.



Program Codes

Enter a key sequence:

KY<code>[, <code>]...

code ::= integer
[d]d

Key codes are listed in tables 3-15 and 3-16.

Example Execute the keystroke sequence 

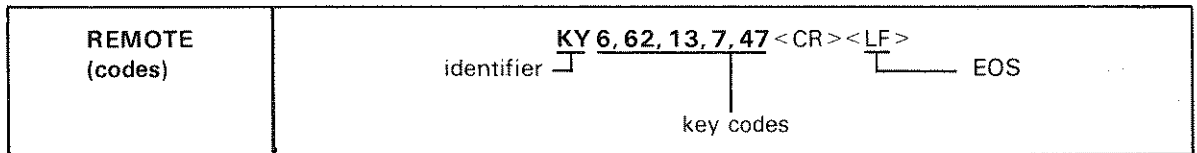

Indication The KY command executes as front-panel keystrokes. The same indications result as in local operation.

Comments Although the KY command is interpreted as a keystroke, it does not affect the "last key code" instrument status qualifier.

If the last key code is read when no key has been pressed since power-on, the code "64" is output by the 1980A/B.

Related Sections

- Control Knob
- Delta Time
- Instrument Status
- Service Request Condition
- Soft Key Menus



Key (Cont'd)

Table 3-15. Key to Keycode Conversion Table

Display Panel		Control Panel		Voltage Panel			
Key	Code	Key	Code	Key	Code	Key	Code
	49		63		55		21
	50		62		47		14
	51		61		39		22
	52		54		31		29
	56		*		6		37
	57				23		45
	58				5		30
	59				15		38
	60				13		46

Time Panel				Probe Keys			
Key	Code	Key	Code	Key	Code	Key	Code
	1		32		3	Channel 1	65
	9		40		36	Channel 2	66
	17		16		35	Main Trigger	67
	25		24		20	Dly'd Trigger	68
	0		34		11		
	8		42		44		
	18		2		43		
	26		10		28		
	33		19		27		
	41		4		12		

* is not programmable, no code is assigned.

Key (Cont'd)



Table 3-16. Keycode to Key Conversion Table

Code	Key	Code	Key	Code	Key	Code	Key
0	(main)	18	(dly'd)	36	(dly'd)	54	
1		19		37	(ch 1)	55	
2		20	(dly'd)	38	(ch 2)	56	
3	(main)	21		39		57	
4		22		40		58	
5	(ch 1)	23	(ch 2)	41		59	
6	(ch 1)	24		42		60	
7		25		43	(main)	61	
8	(main)	26	(dly'd)	44	(dly'd)	62	
9		27	(main)	45	(ch 1)	63	
10		28	(dly'd)	46	(ch 2)	64	*
11	(main)	29	(ch 1)	47		65	Probe 1
12	(dly'd)	30	(ch 2)	48	unused	66	Probe 2
13		31		49		67	Main Probe
14		32		50		68	Dly'd Probe
15	(ch 2)	33		51		69	unused
16		34		52			
17		35	(main)	53	unused		

*Code 64 means no key has been pressed since power-on.



Learn Mode

Description The 1980A/B has learn mode capability which uses the HP-IB controller memory to store instrument configurations. Learn mode provides a fast means of configuring the 1980A/B from an HP-IB controller, and also, a compact format in which instrument setups can be stored.

The learn string contains all of the information that is stored in the Save/Recall registers. In other words, it includes all variable function parameter values, and all state or mode selections.

Procedure The learn string is transferred as binary data between the 1980A/B and the HP-IB system controller.



Program Codes

Command the 1980A/B to output a learn string:

TE

Then address the 1980A/B to talk. The learn string comprises 80, 8 bit bytes. End-of-String is indicated by setting the EOI bus control line true with the 80th byte.

To configure the 1980A/B using learn mode, send a previously acquired learn string as a Data message:

<80 byte string><CR><LF>

Comments The learn string must be transferred using a technique that does not send the unlisten (UNL) or untalk (UNT) bus commands. If the 1980A/B is unaddressed during Data message transfers, the transfer is aborted.

Related Sections Remote Operation (paragraph 3-21)
Save/Recall

Power-on Sequence and Default Conditions



Description When power is switched on, the 1980A/B performs a series of internal checks. These are transparent to the operator unless an error is found. The following conditions may be encountered at power-on:

Hardware error. If a hardware error is detected, an error message is displayed in the LED readout. Error codes and recommended responses are described in the "Error Messages" Detailed Operating Instruction. Pressing any key except  clears the error display.

CAL factor switch. If the calibration factor protection switch is in the NOT PROTECTED position, the advisory CAL MEMORY NOT PROTECTED is displayed. Put switch in the PROTECTED position or press any key except  to turn off the advisory.

At power-on, the instrument is configured in the state that existed when power was disconnected. However, the following default conditions occur:

- * Soft key menus turned off
- * Advisory messages enabled
- * CRT readout enabled
- * DC 50 Ω vertical or trigger couplings changed to DC.
- * HP-IB switched to local mode
- * Local-lockout cleared
- * Unaddressed (if in addressable mode)
- * RQS mask cleared
- * Require Service message cleared
- * Status byte register cleared
- * HP-IB status advisory enabled

Related Sections Error Messages



Reading Values Via HP-IB

Description All variable function parameter values can be read via the HP-IB. Output Data message format for each parameter is described in table 3-17.

Procedure Send a command to select the desired output data, then address the 1980A/B to talk.



Program Codes

Select parameter value to be output:

OF<code>

- | | |
|----------|-------------------------------|
| code ::= | 1 channel 1 deflection factor |
| | 2 channel 2 deflection factor |
| | 3 main sweep speed |
| | 4 delayed sweep speed |
| | 5 channel 1 ΔV value |
| | 6 channel 2 ΔV value |
| | 7 channel 1 position |
| | 8 channel 2 position |
| | 9 dual separation |
| | 10 horizontal position |
| | 11 main trigger level |
| | 12 delayed trigger level |
| | 13 delay time |
| | 14 ΔT value |
| | 15 digital delay |

Example Select channel 1 position value as data output.

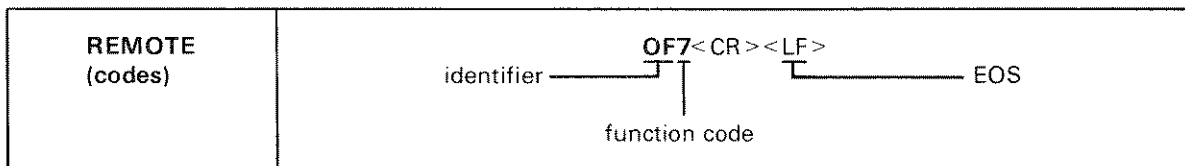

Comments The 1980A/B outputs "E" (uppercase) as the delimiter between the mantissa and exponent in exponential values.

Related Sections
 Control Knob
 Instrument Status
 Service Request Condition
 Trigger Flag

Reading Values Via HP-IB (Cont'd)



Table 3-17. Data Message Output Format

Variable Function	Units	Output Format
channel 1 deflection factor	V/div	<SP>{+ -} d/dde {+ -} dd <CR><LF>
channel 2 deflection factor	V/div	
channel 1 ΔV	Volts	
channel 2 ΔV	Volts	
main sweep speed	sec/div	<SP>d.ddE {+ -} dd <CR><LF>
delayed sweep speed	sec/div	
channel 1 position	div	<SP> {+ -} dd.dd <CR><LF>
channel 2 position	div	
horizontal position	div	
dual separation	div	
main trigger level	div Volts Volts Volts	Format and units depend upon the selected trigger source:
delayed trigger level		LINE, INT: <SP> {+ -} dd.dd <CR><LF>
		EXT \div 1: <SP> {+ -} d.ddd <CR><LF>
		EXT \div 10: <SP> {+ -} dd.dd <CR><LF>
	EXT \div 100: <SP> {+ -} ddd.d <CR><LF>	
delay time	sec	<SP>d.d[d...]E-dd <CR><LF> ! 9 digits maximum
ΔT	sec	<SP>[+ -]d.d[d...]E-dd <CR><LF> ! 9 digits maximum
digital delay	events	<SP>[d...]d <CR><LF> ! 7 digits maximum

Save/Recall (Cont'd)

Comments To quickly load the Save/Recall registers via HP-IB, configure the instrument with a learn string, then save the state in the desired register.

Related Sections Learn Mode

Table 3-18. Functions Stored in Save/Recall Registers

Instrument Function	Parameters Stored
Advisory Messages	state
Bandwidth Limit	state
Character Generator	state
Control Knob	assignment
Delay	value, step resolution
Delta Time	state, value, step resolution
Delta Volts	state, value, step resolution
Horizontal Position	value, step resolution
Horizontal Mode	state
HP-IB Status Advisory	state
Intensity, Characters	value, step resolution
Intensity, Lamps	value, step resolution
Intensity, Trace	main and delayed value, step resolution
Scope Mode	state
Separation, Dual	value, step resolution
Sweep Mode, Delayed	state
Sweep Mode, Main	state
Sweep Speed, Delayed	value, step resolution
Sweep Speed, Main	value, step resolution
Trigger, Delayed	level value, source, slope, coupling
Trigger, Main	level value, source, slope, coupling
Trigger View	state
Vertical Coupling (ch 1 & 2)	state
Vertical Deflection Factor (ch 1 & 2)	value, step resolution
Vertical Mode	state
Vertical Position (ch 1 & 2)	value, step resolution

Scope Mode

Description The 1980A/B has 3 basic display modes: Volts vs time, channel 1 vs channel 2, and external X·Y·Z. This instruction provides a description of these modes and general advice on their use.

V vs T is the most commonly used scope mode. Channel 1 or 2 signal inputs (Y-axis) are plotted versus timebase signals (X-axis). In V vs T, vertical and horizontal modes can be selected to enable convenient voltage and timing measurements.

1 vs 2 selects an X-Y operating mode. Channel 1 signals are plotted versus channel 2 signals (X-axis). This mode turns on channel 1 and 2, and it enables their controls. The timebases are disabled.

X·Y·Z is a display operating mode using the rear-panel X, Y, and Z-blanking signals. It is designed to accept the output of an HP model 1607A for logic state analysis. This mode disables channels 1 and 2, and the timebases.

Scope Mode Characteristics

V vs T Mode

Y-axis

bandwidth dc to 100 MHz (limit off)
deflection factor 2 mV/div to 10 V/div

X-axis

timebase range 5 nsec/div to 1 sec/div

1 vs 2 Mode

Y-axis (channel 1)

bandwidth dc to 100 MHz (limit off)
deflection factor 2 mV/div to 10 V/div

X-axis (channel 2)

bandwidth dc to 4 MHz
deflection factor 2 mV/div to 10 V/div
Phase difference $\leq 3^\circ$, dc to 100 kHz

X·Y·Z Mode

Y-axis

bandwidth dc to ~50 MHz
deflection factor 0.4 V/div $\pm 20\%$
maximum input ± 10 Vrms

X-axis



bandwidth dc to ~5MHz
deflection factor 0.5 V/div $\pm 20\%$
maximum input ± 10 Vrms

Z-axis

bandwidth dc to 10 MHz
sensitivity +4 V pulse ≥ 50 nsec wide blanks display
maximum input +5 V peak ac + dc

Scope Mode (Cont'd)

Procedure To select the scope mode, press the corresponding key:

-  V vs T mode
-  1 vs 2 mode
-  X·Y·Z mode



Program Codes

Select scope mode:

SM< mode >

- mode ::=
- 1 V vs T
 - 2 1 vs 2
 - 3 X·Y·Z

Example Select 1 vs 2 mode.

LOCAL (keys)	
REMOTE (codes)	<p>identifier ——— SM2 <CR> <LF> ——— EOS</p> <p style="margin-left: 100px;"> </p> <p style="margin-left: 100px;">mode</p>

Indication The selected scope mode is indicated by the lighted scope mode key.

If the CRT readout is on, scope mode is also indicated by the information that is displayed. In V vs T, both vertical channel and timebase information is displayed. In 1 vs 2 mode, only vertical channel information is displayed. In X·Y·Z mode, there is no CRT readout information displayed.

Comments In 1 vs 2 mode, channel 2 invert is not permitted.

When the instrument is switched from 1 vs 2 to V vs T mode, channel 2 is reset to noninverted display.

Related Sections Horizontal Mode
Vertical Mode

Separation, Dual

Description When the instrument is in dual sweep horizontal mode, the vertical separation of the main and delayed sweep traces may be adjusted to improve visibility.

Dual Separation Characteristics

range -5.00 div to +5.00 div
 resolution 0.02 div

Procedure To change dual separation, press  and adjust Control Knob for desired value. Separation can only be adjusted when dual horizontal mode is selected.



Program Codes

Enter separation value:

SP<value>

value ::= decimal
 [+|-][d].d[d]
 -5.00 div to +5.00 div

Example Enter a dual separation value of +4.50 divisions.

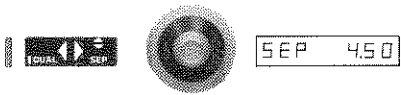
<p>LOCAL (keys)</p>	
<p>REMOTE (codes)</p>	<p>identifier <u>SP+4.50</u> <CR> <LF> EOS</p> <p style="margin-left: 100px;"> </p> <p style="margin-left: 100px;">separation value</p>

Indication When the Control Knob is assigned to dual separation,  is lighted and separation value is displayed by the LED readout.

Comments If an odd integer (to the nearest hundredth) is entered via the HP-IB, it will be rounded to the nearest even value; positive values are rounded down, negative values are rounded up.

Related Sections Control Knob
 Horizontal Mode

Service Request Condition



Description This instruction explains how to set the interrupt mask (RQS mask) for the Require Service message. The related sections listed at the end of this instruction describe the instrument's serial poll capability and the status information that can be obtained.

Procedure The service request condition cannot be set or displayed from the front-panel of the instrument.



Program Codes

Enter the RQS mask value:

IM <value>

value ::= integer
 ddd
 $0 \leq \text{value} \leq 255$
 (refer to table 3-19)

The mask value is the sum of the weights of the conditions that are to be enabled. The value 64 is assigned to the RQS bit, and does not affect the interrupt mask. If it is not added into the total mask value, it will be assumed by the instrument.

The mask value of "0" inhibits the Require Service message, but enables all conditions to be read in a single Status Byte message.

Table 3-19. RQS Mask Value for Service Request Conditions

Condition	Weight
HP-IB Syntax Error	1
Key Closure (except <small>SRQ</small> BEAM, <small>SRQ</small> ERROR)	2
End of Sweep (after SG command)	4
1980A/B Advisory or Error Message	8
Internal Option request	16
Plug-in Option request	32
<small>SRQ</small> ERROR	128

Example Enable the Require Service message upon closure of SRQ ERROR or detection of HP-IB syntax error.

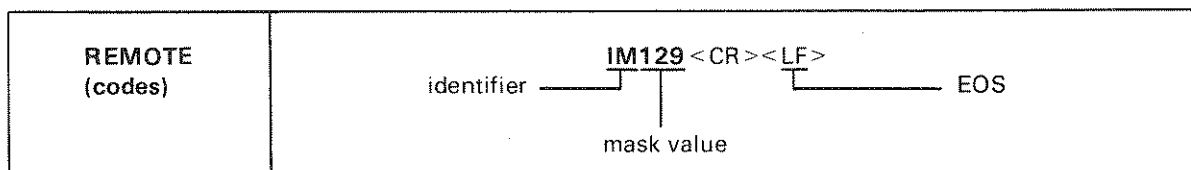



Service Request Condition (Cont'd)

Indication

There is no indication of the mask value being entered. However, when an enabled service request condition occurs, the HP-IB status advisory displays \mathcal{S} until the status byte message is read by the controller.

Comments

The interrupt mask is reset to "0" (no conditions enabled) at power-on and when the HP-IB ADDRESS MODE menu is displayed.

Related

Advisory Messages

Sections

Error Messages

Instrument Status

Key

Remote Operation (paragraph 3-21)

Trigger Flag

Soft Key Menus (Cont'd)

Indication When a menu is on or a menu function is executing,  is lighted.

Comments If character intensity is less than level 35, when the menus are called with , character intensity is preset to level 35.

Calling the soft key menus turns on the CRT readout. It also erases any text written on screen via HP-IB.

Related Sections

- Advisory Messages
- Character Generator
- Confidence Test (paragraph 3-45)
- Delay Time Self-cal (paragraph 3-49)
- HP-IB Address
- Initialize
- Key
- Memory Check (paragraph 3-46)
- Save/Recall
- Vertical Balance Self-cal (paragraph 3-50)

Soft Key Menus (Cont'd)

Table 3-20. Soft Key Menu Tree

level 1:			
OPTION MENU			
Soft Key #			
0	MENU OFF		
1	PRESET		
2	CALIBRATE & UTILITIES		
3	CONFIDENCE TEST 1980A/B		
4	FEATURE ROMS		
5	19842A HP-IB		
6	disabled ¹		
7	disabled ²		
8	OPTION MENU OFF		
level 2:			
	CALIBRATE & UTILITIES	CONFIDENCE TEST 1980A/B	INSTALLED OPTION LIST
Soft Key #			
0	MENU OFF	execute test	MENU OFF
1	DELAY SELF-CAL	execute test	disabled ³
2	BALANCE SELF-CAL	execute test	disabled ³
3	BAL. & DELAY SELF-CAL	execute test	disabled ³
4	UTILITIES	execute test	disabled ³
5	disabled ¹	execute test	disabled ³
6	FRONT PANEL CAL 1980A/B	execute test	disabled ³
7	disabled ²	execute test	disabled ³
8	PREVIOUS MENU	PREVIOUS MENU	PREVIOUS MENU
	19842A HP-IB (addressable)	19842A HP-IB (listen only)	19842A HP-IB (talk only)
Soft Key #			
0	MENU OFF	MENU OFF	MENU OFF
1	normal function	normal function	normal function
2	normal function	normal function	normal function
3	INCREMENT ADDRESS	disabled	disabled
4	DECREMENT ADDRESS	disabled	disabled
5	disabled	disabled	disabled
6	CHANGE ADDRESS MODE	CHANGE ADDRESS MODE	CHANGE ADDRESS MODE
7	disabled	disabled	disabled
8	PREVIOUS MENU	PREVIOUS MENU	PREVIOUS MENU
level 3:			
UTILITIES			
Soft Key #			
0	MENU OFF		
1	normal function		
2	normal function		
3	ADVISORIES ON		
4	ADVISORIES OFF		
5	RAM TEST		
6	ROM CHECKSUM		
7	TNT ADJ DELAY OSC RANGE		
8	PREVIOUS MENU		

NOTES: 1 reserved for internal enhancement menu
 2 reserved for plug-in enhancement menu
 3 reserved for feature ROM menu

Sweep Mode, Delayed



Description There are three modes of delayed sweep operation: Auto sweep after delay, triggered sweep after delay, and triggered sweep after digital (events) delay.

In auto sweep after delay (auto-sweep) mode, the delay value determines the time interval from the main sweep trigger until the delayed sweep begins. The delay time circuit is calibrated so that delayed sweep can start from 0 to 9.99 sec after the main sweep trigger.

In triggered sweep after delay (triggered) mode, the delay value determines the time interval from the main sweep trigger until the delayed sweep trigger circuit is armed. This mode provides a time-referenced trigger holdoff.

In digital delay mode, the delay value is expressed as trigger events. The delayed sweep begins after the specified number of delayed triggers have occurred. This mode is useful when examining clocked serial data.

Procedure Select the delayed sweep mode with these keys:

-  auto-sweep
-  triggered sweep
-  digital delay

Both main and delayed sweep can be reset by pressing .



Program Codes

Select delayed sweep mode:

DM < mode >

- mode ::= 1 triggered sweep
- 2 auto-sweep
- 3 digital delay

Example Select triggered delayed sweep mode.

LOCAL (keys)	
REMOTE (codes)	<p>identifier ——— <u>DM1</u> <CR> <LF> ——— EOS</p> <p style="margin-left: 100px;"> </p> <p style="margin-left: 100px;">mode</p>

Indication The delayed sweep mode is indicated by lighting the corresponding key.

In auto-sweep and triggered-sweep modes, the delay value is expressed in terms of time. The CRT readout displays $Dly Tm = <delay>$.

In digital delay mode, delay is expressed in terms of events and the CRT readout displays $Dig Dly = <delay>$.

The NOT indicator is lighted if main sweep is armed and not triggered.

Comments In digital delay mode, the NOT indicator is disabled.

Related Sections Delay
Sweep Mode, Main
Trigger, Delayed Sweep
Trigger, Main Sweep
Trigger Flag

Sweep Mode, Main



Description There are three basic modes of main sweep operation: Auto-start, triggered, and single. These sweep modes can be selected from the front-panel or via the HP-IB.

In auto-start, the main sweep is triggered by an internal oscillator (~10 Hz) if no trigger signal is present. This mode is convenient since it ensures a trace baseline if delayed sweep is off or in auto-sweep mode.

In triggered mode, main sweep only occurs after it is triggered. Triggered mode is recommended if the trigger repetition rate is less than 10 Hz.

In single mode, main sweep functions as in triggered. However, after one sweep, the sweep circuit must be reset from the front-panel or via HP-IB before the next sweep can occur.

Procedure Select main sweep mode with the following keys:

-  auto-start
-  triggered
-  single

Reset main sweep in any mode by pressing .



Program Codes

Select main sweep mode:

MM < mode >

- mode ::= 1 triggered
- 2 auto-start
- 3 single sweep
- 4 reset

Example Select triggered main sweep mode.

LOCAL (KEYS)	
REMOTE (codes)	<pre> identifier ——— MM1 < CR > < LF > ——— EOS mode </pre>

Sweep Mode, Main (Cont'd)

Indication The main sweep mode is indicated by lighting the corresponding key.

The NOT indicator is lighted when the main sweep is armed and not triggered.

Related Sections Delay
Sweep Mode, Delayed
Trigger, Main Sweep
Trigger, Delayed Sweep
Trigger Flag

Sweep Speed, Delayed

Description The sweep speed of the the delayed timebase is adjustable from the front-panel or via the HP-IB. Delayed sweep speed is independent of main sweep speed, any value within the specified range can be entered.

Delayed Sweep Characteristics

range	5.00 nsec/div to 1 sec/div
resolution	3 digits
accuracy*	
5 nsec/div to 9.99 nsec/div	±3%
(center 8 div)	
10 nsec/div to 9.99 msec/div	±3%
(first 10 div)	
10 msec/div to 1 sec/div	±4%
(first 10 div)	

* Within ±10° C of calibration temperature. For temperature beyond ±10° C, and within 0 to 55° C, add 1% for sweep speeds from 5 nsec/div to 500 msec/div to 1 sec/div.

Procedure Press  and adjust delayed sweep speed with the Control Knob.

Select fine or coarse step resolution with . In coarse, steps are in a 100,150,200,300...900 sequence. In fine, steps are change of 1 in least significant digit.





Program Codes

DS <value>

value ::= exponential
 [+] {n.dd|nd.d|ndd} {E|e}{+|-|<SP>}[d] d
 5.00e-09 to 9.99e-00 sec/div

Example Change delayed sweep speed to 10 μsec/div.

LOCAL (keys)	 (dly'd)  10.0 -6
REMOTE (codes)	identifier <u>DS + 10.0e-06</u> <CR><LF> EOS sweep speed value

Sweep Speed, Delayed (Cont'd)

Indication Delayed sweep speed is displayed by the CRT readout. When the Control Knob is assigned to delayed sweep speed,  is lighted and the parameter value is displayed by the LED readout. Also, the CRT readout indicates Control Knob assignment by displaying $DLYd=$ in inverse video.

Comments If delayed sweep speed is much less than main sweep speed, the 1980A/B displays the advisory LONG HOLDOFF BY SLOW DLY SW when  is pressed and when the delayed sweep speed is changed.

When automatic vertical display mode selection is enabled () , delayed sweep speeds less than 1 msec/div cause chop mode to be selected.

Related Sections

- Control Knob
- Delay
- Intensity, Trace
- Reading Values Via HP-IB
- Sweep Mode, Delayed
- Sweep Speed, Main
- Vertical Mode

Sweep Speed, Main

Description The sweep speed of the main timebase can be entered from the front-panel or via the HP-IB. Main sweep speed is independent of delayed sweep speed, any value within the specified range can be entered.

Main Sweep Characteristics

range	5.00 nsec/div to 1 sec/div
resolution	3 digits
accuracy*	
5 nsec/div to 9.99 nsec/div	±3%
(center 8 div)	
10 nsec/div to 9.99 msec/div	±3%
(first 10 div)	
10 msec/div to 1 sec/div	±4%
(first 10 div)	

* Within ±10°C of calibration temperature. For temperatures beyond ±10°C, and within 0 to 55°C, add 1% for sweep speeds from 5 nsec/div to 500 msec/div; add 2% for sweep speeds from 500 msec/div to 1 sec/div.

Procedure Press  and adjust main sweep speed with the Control Knob.

Select fine or coarse step resolution with . In coarse, steps are in a 100,150,200,300...900 sequence. In fine, steps are change of 1 in least significant digit.



Program Codes



Enter the main sweep speed value:

MS<value>

value ::= exponential
 [+] {n.dd|nd.d|nnd} {E|e}{+|-|<SP>}|d|d
 5.00e-09 to 9.99e-00 sec/div

Sweep Speed, Main (Cont'd)

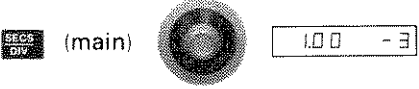
Example Change main sweep speed to 1 msec/div.

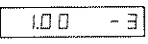
LOCAL (keys)	 (main)  
REMOTE (codes)	identifier <u>MS + 1.00e-03</u> <CR> <LF> EOS sweep speed value

Indication Main sweep speed is displayed by the CRT readout. When the Control Knob is assigned to main sweep speed,  is lighted and the parameter value is displayed by the LED readout. Also, the CRT readout indicates Control Knob assignment by displaying MAIN= in inverse video.

Comments If main sweep speed is much less than delayed sweep speed, the 1980A/B displays the advisory LONG HOLDOFF BY SLOW MAIN SW when  is pressed and when the main or delayed sweep speed is changed.

When automatic vertical display mode selection is enabled () , main sweep speeds less than 1 msec/div cause chop mode to be selected.

- Related Sections**
- Control Knob
 - Delay
 - Intensity, Trace
 - Reading Values Via HP-IB
 - Sweep Mode, Delayed
 - Sweep Speed, Main
 - Vertical Mode



Text Display

Description The 1980A/B character generator can be programmed via the HP-IB to write special messages on the CRT. The available display area is shown in figure 3-20.

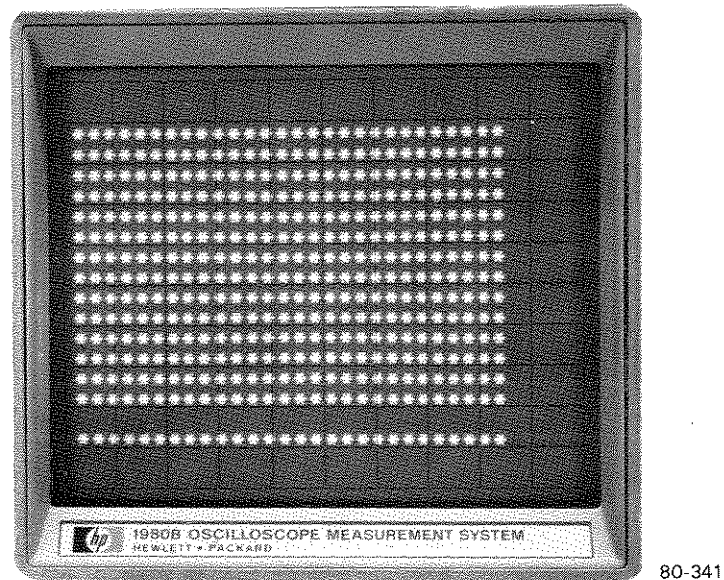



Figure 3-20. Text Field in the 1980A/B CRT Display

Procedure Text cannot be entered from the front-panel, however, the text field can be toggled on or off with .



Program Codes

Erase text field:

TX

Erase text line:

TX<line #>

line # ::= integer
dd
1-14, 16

Text Display (Cont'd)



Write text line:

TX<line #>,<string>

line # ::= integer
 dd
 1-14, 16

string ::= 1 to 28 characters
 1980A/B character set, table 3-22

Write text with display attributes:

CH<line #>,<string>

line # ::= integer
 dd
 1-14, 16

string ::= 7 to 28 bytes, counting characters and attributes

String must contain 4 attributes

Attributes must be separated by at least one character

First byte must be an attribute

Table 3-21. Special Text Attributes

Display Attribute	Octal	Decimal
normal	200	128
inverse	220	144
blinking	202	130
underline	240	160
blinking and inverse	222	146
inverse and underline	260	176
blinking and underline	242	162
inverse, blinking & underline	262	178



Text Display (Cont'd)

Comments If a soft key menu is called, all text programmed to the display is cleared.

Related Sections Character Generator
Intensity, Characters and Lamps
Soft Key Menus

Table 3-22. 1980A/B Modified ASCII Character Set

decimal	char	decimal	char	decimal	char	decimal	char
0	␣	32	<SP>	64	@	96	"
1	␣	33	!	65	A	97	␣
2	␣	34	"	66	B	98	␣
3	␣	35	#	67	C	99	␣
4	␣	36	\$	68	D	100	␣
5	␣	37	%	69	E	101	␣
6	␣	38	&	70	F	102	␣
7	␣	39	'	71	G	103	␣
8	␣	40	(72	H	104	␣
9	␣	41)	73	I	105	␣
10 *	<LF>	42	*	74	J	106	␣
11	␣	43	+	75	K	107	␣
12	␣	44	,	76	L	108	␣
13 *	<CR>	45	-	77	M	109	␣
14	␣	46	.	78	N	110	␣
15	␣	47	/	79	O	111	␣
16	␣	48	0	80	P	112	␣
17	␣	49	1	81	Q	113	␣
18	␣	50	2	82	R	114	␣
19	␣	51	3	83	S	115	␣
20	␣	52	4	84	T	116	␣
21	␣	53	5	85	U	117	␣
22	␣	54	6	86	V	118	␣
23	␣	55	7	87	W	119	␣
24	␣	56	8	88	X	120	␣
25	␣	57	9	89	Y	121	␣
26	␣	58	:	90	Z	122	␣
27	␣	59 *	;	91	[123	␣
28	␣	60	<	92	\	124	␣
29	␣	61	=	93]	125	␣
30	␣	62	>	94	^	126	␣
31	␣	63	?	95	_	127	␣

* <LF>, <CR>, and ";" are not permitted within text strings.

Trigger, Delayed Sweep



Description The trigger source, level, slope and coupling for delayed sweep may be selected from the front-panel or via the HP-IB.

Delayed Sweep Trigger Characteristics

internal

sensitivity

channel deflection

factor < 10 mV/div > 1.4 div, dc to 25 MHz increasing
to 3 div at 100 MHz

channel deflection

factor ≥ 10 mV/div > 0.7 div, dc to 25 MHz; increasing
to 1.5 div at 100 MHz

range -20.00 div to $+20.00$ div

resolution 0.02 major division

accuracy $\pm(3\%$ of reading $+0.4$ major div)

external $\div 10$

sensitivity > 500 mV p-p, dc to 25 MHz increasing
to 1.2 V p-p at 100 MHz

range -12.0 V to $+12.0$ V

resolution 20 mV

accuracy $\pm(3\%$ of reading $+400$ mV)

external $\div 1$

sensitivity > 50 mV p-p, dc to 25 MHz increasing
to 120 mV p-p at 100 MHz

range -12.0 V to $+12.0$ V

resolution 2 mV

accuracy $\pm(3\%$ of reading $+40$ mV)

external input

AC, DC-coupled

impedance $1\text{ M}\Omega \pm 2\%$ shunted by ~ 15 pF

maximum input refer to figure 3-21

DC 50Ω coupled

impedance $50\Omega \pm 3\%$ shunted by ~ 15 pF

maximum input refer to figure 3-21

HF reject -3 dB at ~ 35 kHz

LF reject -3 dB at ~ 35 kHz

Trigger, Delayed Sweep (Cont'd)

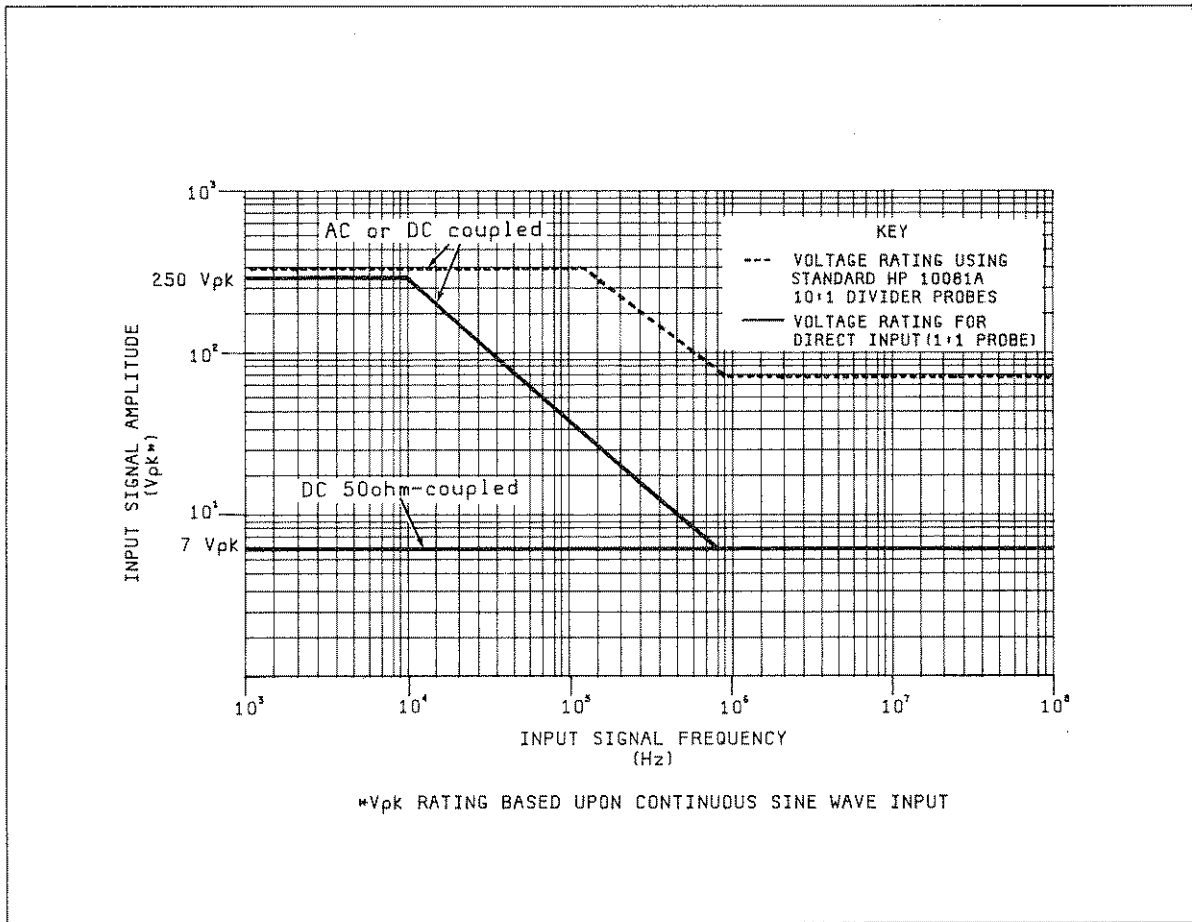

1980/161

Figure 3-21. Maximum Signal Input vs Frequency ≥ 1 kHz

Procedure Select delayed trigger source with the following keys:

	internal, channel 1
	internal, channel 2
	external, input $\div 10$
	external, input $\div 1$

To select the internal or external source coupling, press:

	AC coupled
	AC coupled, LF reject
	DC coupled
	DC coupled, 50 Ω (external source only)

Trigger, Delayed Sweep (Cont'd)

Select trigger slope by pressing  (dly'd).

To set trigger level, press  (dly'd) and adjust with Control Knob. If main and delayed trigger views are off, delayed trigger view is displayed while the Control Knob is rotated. The trigger threshold is represented by the center horizontal graticule line.

HF reject for internal or external sources can be toggled on or off by pressing  (dly'd).



Program Codes

Select delayed trigger slope, source and coupling:

DT [**< slope >**] **< source >**, **< coupling >**

slope ::=	<ul style="list-style-type: none"> + low to high transition - high to low transition
source ::=	<ul style="list-style-type: none"> 0 previous source (no change) 1 vertical channel 1 2 vertical channel 2 3 external ÷ 1 4 external ÷ 10
coupling ::=	<ul style="list-style-type: none"> 0 AC 1 AC, LF reject 2 AC, HF reject 3 AC, LF and HF reject 4 DC 5 DC, HF reject 6 DC 50Ω 7 DC 50Ω, HF reject

Trigger, Delayed Sweep (Cont'd)

Enter delayed trigger level:

DL <value>

value ::= integer
 [+|-] dddd
 leading zeroes may be omitted

Trigger level value is interpreted according to the selected trigger source:

internal: dd dd
 1 assumed decimal point
 -20.00 div to +20.00 div

external ÷ 1: d ddd
 1 assumed decimal point
 -1.200 V to +1.200 V

external ÷ 10: dd dd
 1 assumed decimal point
 -12.00 V to +12.00 V

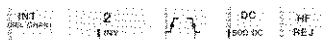
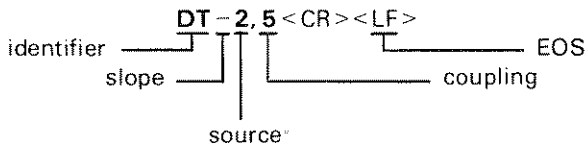

external ÷ 100: ddd d
 1 assumed decimal point
 -120.0 V to +120.0 V

Example Select channel 2 as trigger source, negative slope, DC-coupled with HF reject.

<p>LOCAL (keys)</p>	
<p>REMOTE (codes)</p>	

Trigger, Delayed Sweep (Cont'd)

Set delayed trigger level = 1.60 div.

LOCAL (keys)	  CH2. - 1.60
REMOTE (codes)	<p>identifier ——— DL-160 <CR><LF> ——— EOS</p> <p style="margin-left: 100px;"> </p> <p style="margin-left: 100px;">value</p>

Indication When the Control Knob is assigned to delayed trigger level,  is lighted and the trigger source and level value are displayed by the LED readout.

Trigger source is displayed by the CRT readout and the corresponding source selection key is lighted.

Trigger slope and coupling are indicated by lighting the corresponding keys.

Comments At power-on, DC 50Ω coupling is changed to DC as a default condition.

In triggered or digital delay delayed sweep modes, the setup time of the delayed trigger circuit must be taken into consideration if delayed sweep is to be triggered on the same pulse edge as main. Delayed trigger events cannot be detected until approximately 70 nsec after main trigger.

The delayed external trigger input has a probe key contact. If an external trigger source is connected via a recommended HP 10080 series miniprobe, trigger level is displayed as measured at the probe tip (including the probe division ratio).

A probe key closure at the delayed trigger external input causes a momentary shift in delayed trigger level (any source selected) to identify the trigger view signal.

Related Sections

- Sweep Mode, Delayed
- Sweep Mode, Main
- Trigger, Main Sweep
- Trigger Flag
- Trigger View
- Vertical Deflection Factor
- Vertical Coupling

Trigger, Main Sweep



Description The source, slope, level, and coupling of the trigger for main sweep can be selected from the front-panel or via the HP-IB.

Main Sweep Trigger Characteristics

internal

sensitivity

channel deflection

factor < 10 mV/div > 1.4 div, dc to 25 MHz increasing to 3 div at 100 MHz

channel deflection

factor ≥ 10 mV/div > 0.7 div, dc to 25 MHz; increasing to 1.5 div at 100 MHz

range -20.00 div to +20.00 div

resolution 0.02 major division

accuracy $\pm(3\%$ of reading +0.4 major div)

external $\div 10$

sensitivity > 500 mV p-p, dc to 25 MHz increasing to 1.2 V p-p at 100 MHz

range -12.0 V to +12.0 V

resolution 20 mV

accuracy $\pm(3\%$ of reading +400 mV)

external $\div 1$

sensitivity > 50 mV p-p, dc to 25 MHz increasing to 120 mV p-p at 100 MHz

range -1.20 V to +1.20 V

resolution 2 mV

accuracy $\pm(3\%$ of reading +40 mV)

line

range ± 20 relative units

resolution 0.02 unit

external input

AC, DC-coupled

impedance $1\text{ M}\Omega \pm 2\%$ shunted by ~ 15 pF

maximum input refer to figure 3-22

DC 50Ω coupled

impedance $50\Omega \pm 3\%$ shunted by ~ 15 pF

maximum input refer to figure 3-22

HF reject -3 dB at ~ 35 kHz

LF reject -3 dB at ~ 35 kHz

Trigger, Main Sweep (Cont'd)

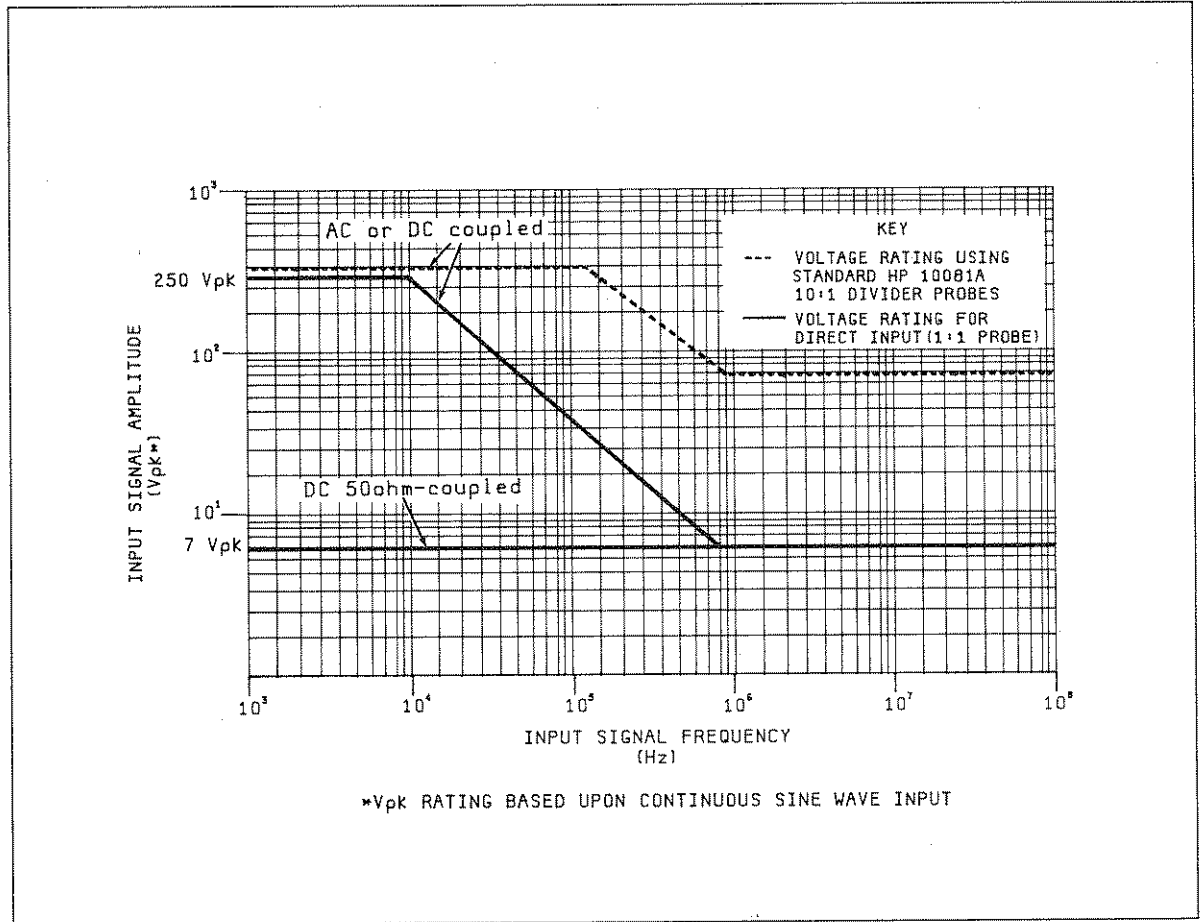

1980/161

Figure 3-24. Maximum Signal Input vs Frequency ≥1 kHz

Procedure Select main trigger source with the following keys:

	1	internal, channel 1
	2	internal, channel 2
		external, input ÷ 10
		external, input ÷ 1
		line

To select the internal or external source coupling, press:

	AC coupled
	AC coupled, LF reject
	DC coupled
	DC coupled, 50Ω

Trigger, Main Sweep (Cont'd)

HF reject for internal or external sources can be toggled on or off by pressing .

Select trigger slope for internal, external or line sources by pressing .

To set trigger level, press  and adjust with Control Knob. If main and delayed trigger views are off, the main trigger view is displayed while the Control Knob is rotated. The trigger threshold is represented by the center horizontal graticule line.



Program Codes

Select main trigger slope, source, and coupling:

MT [**< slope >**] **< source >** , **< coupling >**

slope ::= + low to high transition
 - high to low transition

source ::= 0 previous source (no change)
 1 vertical channel 1
 2 vertical channel 2
 3 external ÷ 1
 4 external ÷ 10
 5 line

coupling ::= 0 AC
 1 AC, LF reject
 2 AC, HF reject
 3 AC, LF and HF reject
 4 DC
 5 DC, HF reject
 6 DC 50Ω
 7 DC 50Ω, HF reject

Enter main trigger level:

ML **< value >**

value ::= integer
 [+|-]dddd
 leading zeroes may be omitted

Trigger, Main Sweep (Cont'd)

Trigger level value is interpreted according to the selected trigger source:

- internal
or line: dd dd
 ↑ assumed decimal point
 -20.00 div to +20.00 div

- external ÷ 1: d ddd
 ↑ assumed decimal point
 -1.200 V to +1.200 V

- external ÷ 10: dd dd
 ↑ assumed decimal point
 -12.00 V to +12.00 V

- external ÷ 100: ddd d
 ↑ assumed decimal point
 -120.0 V to +120.0 V

Example Select channel 2 as trigger source, negative slope, DC-coupled with HF reject.

LOCAL (keys)	
REMOTE (codes)	<pre> identifier MT-2,5 <CR><LF> slope source coupling EOS </pre>

Enter main trigger level of -1.60 divisions.

LOCAL (keys)	
REMOTE (codes)	<pre> identifier ML-160 <CR><LF> value </pre>

Trigger, Main Sweep (Cont'd)

Indication When the Control Knob is assigned to main trigger level,  is lighted and the trigger source and level value is displayed by the LED readout.

Trigger source is displayed by the CRT readout and the corresponding source selection key is lighted.

Trigger slope and coupling are indicated by lighting the corresponding keys.

Comments At power-on, DC 50 Ω coupling is changed to DC as a default condition.

The main external trigger input has a probe key contact. If an external trigger source is connected via a recommended HP 10080 series miniprobe, trigger level is displayed as measured at the probe tip (including the probe division ratio).

A probe key closure at the main trigger external input causes a momentary shift in main trigger level (any source selected) to identify the trigger view signal.

Related Sections

- Sweep Mode, Delayed
- Sweep Mode, Main
- Trigger, Delayed Sweep
- Trigger View
- Vertical Deflection Factor
- Vertical Coupling



Trigger Flag

Description The trigger flag is a trigger circuit output that can be monitored via the HP-IB. It is used in remote operation to detect trigger events and to make voltage and timing measurements.

Trigger flag detects whether a valid trigger event occurred. Either the main or delayed trigger can be selected to set the flag. There are two modes of trigger flag operation, latched and dynamic:

In latched mode, the selected trigger signal must make a transition through the trigger threshold level, with the selected slope, during delayed sweep, to set the flag to "1". Figure 3-23 contains examples of trigger flag state when latched mode is selected.

In dynamic mode, the flag "follows" the trigger signal. With positive trigger slope selected, the flag is "1" while the trigger signal is greater than the trigger level. With negative slope selected, the flag is "1" while the trigger signal is less than the trigger level. Figure 3-24 contains an example of trigger flag state in dynamic mode.

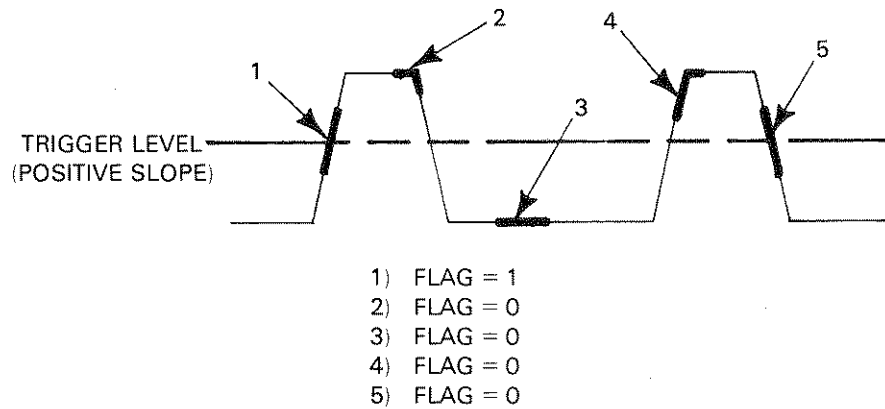

Figure 3-23. Latched Mode Trigger Flag State Examples

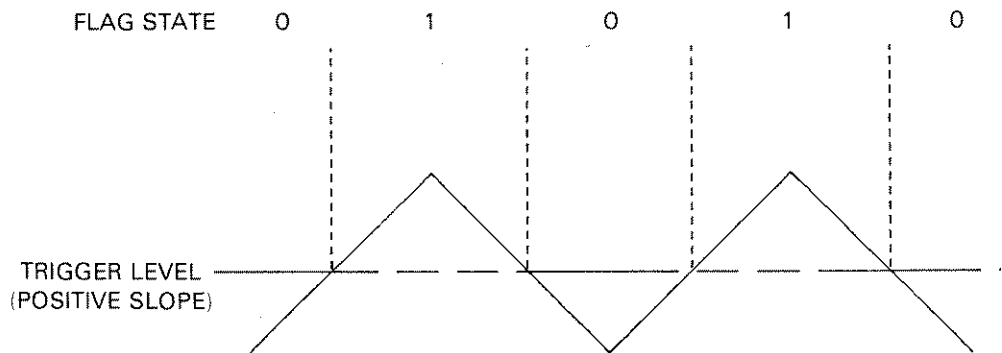

Figure 3-24. Dynamic Mode Trigger Flag State Example



Trigger Flag (Cont'd)

A special horizontal mode must be selected to use the trigger flag. This mode is enabled with the program code "SG". This command puts main sweep in single mode, resets the sweeps and initializes the trigger flag.

The "SG" command does not affect any of the variable function parameters.

The 1980A/B can be programmed to issue the Require Service message at the completion of "SG" enabled sweeps. Also, a timer can be set to cause Require Service after a maximum sweep wait time has expired. The procedure for enabling Require Service after "SG" enabled sweeps or timeout is described in the "Service Request Condition" Detailed Operating Instruction.

Procedure Follow this general procedure when making trigger flag measurements:

Preset horizontal and vertical functions for the measurement procedure.

Set the trigger flag mode and enter the sweep wait time.

Enter RQS mask value for end of sweep if SRQ interrupt is desired.

Start search with "SG" command and wait for end of sweep or timeout interrupt (or test status byte for these conditions).

Test trigger flag state.



Program Codes

Set trigger flag mode:

TF < mode >

- | | | |
|----------|---|---------------------------------|
| mode ::= | 1 | delayed trigger source, latched |
| | 2 | delayed trigger source, dynamic |
| | 3 | main trigger source, latched |
| | 4 | main trigger source, dynamic |

Trigger Flag (Cont'd)



Enter maximum sweep wait time:

SW<factor 1>,<factor 2>,<factor 3>

factor 1 ::= integer
 ddd
 0 to 000
 units of 23 μ sec

factor 2 ::= integer
 ddd
 0 to 999
 units of 5.84 msec

factor 3 ::= integer
 ddd
 0 to 999
 units of 1.5 sec

Example Program the trigger flag to detect a trigger from the delayed trigger source during delayed sweep. Set maximum wait time = 40.6 msec and enable sweep.

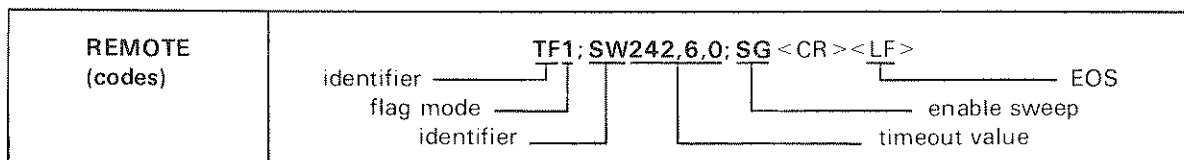

Comments After the program code "SG" is sent to the 1980A/B, it is in a special state that is not indicated on the front panel. After executing a routine using "SG", proper instrument state can be restored by sending the program code "SM1" (selecting V vs T mode).

If the main trigger source-latched mode is selected, the delay value must be set to zero for proper operation. In latched mode, the duration of delayed sweep must be considered. Sweep length is not calibrated and can increase from the nominal 11 divisions to more than 40 divisions at fast sweep speeds.

- Related Sections**
- Delay
 - Instrument Status
 - Horizontal Mode
 - Reading Values Via HP-IB
 - Service Request Condition
 - Sweep Mode, Delayed
 - Sweep Mode, Main
 - Trigger, Delayed Sweep
 - Trigger, Main Sweep

Trigger View

Description Trigger view displays the main or delayed trigger signal. This feature is a useful aid when configuring the trigger circuits. It can also be used as a "third channel" to display reference waveforms. However, trigger view should not be used as a measurement channel.

Trigger view has two operating modes. Normally, main or delayed trigger view is displayed only while the trigger level for that sweep is being changed with the Control Knob. If desired, trigger view can also be turned on continuously from the front-panel or via the HP-IB.

Procedure To toggle main trigger view on or off, press .

To toggle delayed trigger view on or off, press .



Program Codes

Select trigger view mode:

TV <mode>

- mode ::=
- 0 view off (momentary display)
 - 1 main trigger view
 - 2 delayed trigger view

Example Turn on delayed trigger view.

LOCAL (keys)	
REMOTE (codes)	<pre> identifier ——— TV2 < CR > < LF > ——— EOS mode </pre>

Trigger Flag (Cont'd)



Enter maximum sweep wait time:

SW<factor 1>,<factor 2>,<factor 3>

factor 1 ::= integer
ddd
0 to 000
units of 23 μ sec

factor 2 ::= integer
ddd
0 to 999
units of 5.84 msec

factor 3 ::= integer
ddd
0 to 999
units of 1.5 sec

Example Program the trigger flag to detect a trigger from the delayed trigger source during delayed sweep. Set maximum wait time = 40.6 msec and enable sweep.

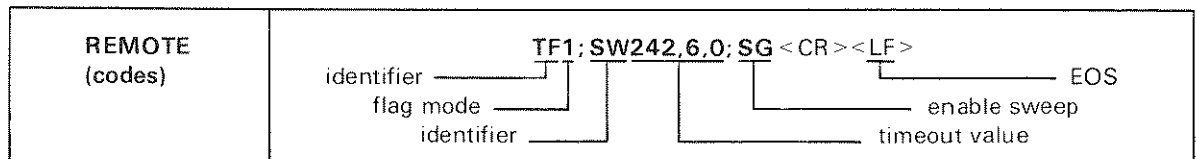

Comments After the program code "SG" is sent to the 1980A/B, it is in a special state that is not indicated on the front panel. After executing a routine using "SG", proper instrument state can be restored by sending the program code "SM1" (selecting V vs T mode).

If the main trigger source-latched mode is selected, the delay value must be set to zero for proper operation. In latched mode, the duration of delayed sweep must be considered. Sweep length is not calibrated and can increase from the nominal 11 divisions to more than 40 divisions at fast sweep speeds.

- Related Sections**
- Delay
 - Instrument Status
 - Horizontal Mode
 - Reading Values Via HP-IB
 - Service Request Condition
 - Sweep Mode, Delayed
 - Sweep Mode, Main
 - Trigger, Delayed Sweep
 - Trigger, Main Sweep

Trigger View

Description Trigger view displays the main or delayed trigger signal. This feature is a useful aid when configuring the trigger circuits. It can also be used as a "third channel" to display reference waveforms. However, trigger view should not be used as a measurement channel.

Trigger view has two operating modes. Normally, main or delayed trigger view is displayed only while the trigger level for that sweep is being changed with the Control Knob. If desired, trigger view can also be turned on continuously from the front-panel or via the HP-IB.

Procedure To toggle main trigger view on or off, press .

To toggle delayed trigger view on or off, press .



Program Codes

Select trigger view mode:

TV <mode >

- mode ::= 0 view off (momentary display)
- 1 main trigger view
- 2 delayed trigger view

Example Turn on delayed trigger view.

LOCAL (keys)	
REMOTE (codes)	<pre> identifier ——— TV2 <CR> <LF> ——— EOS mode </pre>

Trigger View (Cont'd)

Indication When main or delayed trigger view is on, the corresponding key is lighted.

Comments Only one trigger view (main or delayed) can be displayed at one time.

Delayed trigger view cannot be displayed when main horizontal mode is selected.

The center horizontal graticule line represents the trigger threshold level with respect to the trigger view waveform.

The timebase in which the trigger view waveform is displayed depends upon the horizontal mode selected (table 3-23).

Table 3-23. Trigger View Display Timebase

Horizontal Mode	Main Trigger View Timebase	Delayed Trigger View Timebase
Main	Main	Not enabled
Intensified	Intensified	Intensified
Delayed	Delayed	Delayed
Dual	Intensified	Delayed

Related Sections Horizontal Mode
Trigger, Delayed Sweep
Trigger, Main Sweep
Vertical Mode

Vertical Coupling



Description Vertical input coupling can be selected from the front-panel or via the HP-IB. Four input configurations are provided: AC, DC, DC 50Ω, and Ground. The characteristics of each coupling are listed below. Figure 3-25 contains the maximum input voltage derating curve which must be observed for safe operation of the instrument.

Vertical Coupling Characteristics

AC-coupled

bandwidth ~10 Hz to 100 MHz
 impedance 1 MΩ ±2% shunted by ~16 pF
 input voltage refer to figure 3-25

DC-coupled

bandwidth dc to 100 MHz
 impedance 1 MΩ ±2% shunted by ~16 pF
 input voltage refer to figure 3-25

DC 50Ω-coupled

bandwidth dc to 100 MHz
 impedance 50Ω ±3% shunted by 16 pF
 VSWR typically less than 1.3:1
 input voltage 0 to 5 V rms maximum

Ground input connector is disconnected from attenuator, attenuator is grounded through 50Ω.

Procedure Select the vertical coupling for channel 1 or 2 with the following keys:

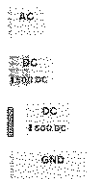

- AC coupled
- DC coupled
- DC 50Ω coupled
- Ground (decoupled)

The instrument accepts coupling key entries only if the channel is on or is a trigger source.

Vertical Coupling (Cont'd)

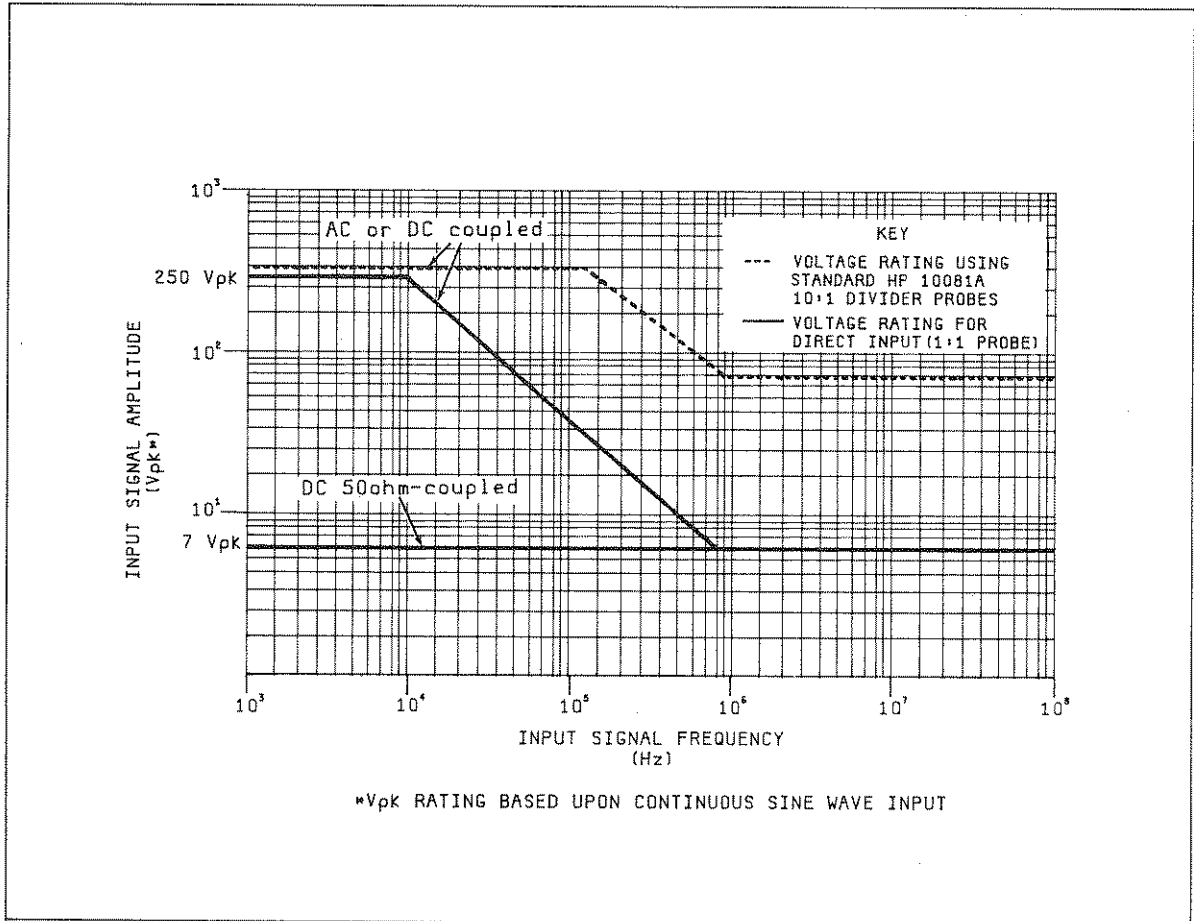

1980/161

Figure 3-25. Maximum Input Voltage vs Frequency

Vertical Coupling (Cont'd)



Program Codes

Select vertical coupling:

VC<channel>,<coupling>

channel ::= 1 channel 1
 2 channel 2

coupling ::= 0 Ground
 1 AC
 2 DC
 3 DC 50Ω

Example Select DC coupling for channel 1.

LOCAL (keys)	
REMOTE (codes)	<div style="display: flex; justify-content: center; align-items: center; gap: 20px;"> <div style="text-align: center;"> <p>VC1, 2 <CR> <LF></p> <p>identifier _____</p> <p>channel _____</p> </div> <div style="text-align: center;"> <p>_____ EOS</p> <p>coupling _____</p> </div> </div>

Indication Vertical coupling is indicated by the lighted coupling key.

Comments At power-on, DC 50Ω coupling is changed to DC as a default condition.

Related Sections Trigger, Delayed Sweep
 Trigger, Main Sweep
 Vertical Position

Vertical Deflection Factor

Description Vertical deflection factor (channel sensitivity) is adjustable from the front-panel or via the HP-IB. Because it is a continuously calibrated function, waveforms can be accurately scaled for vertical axis measurement or reference.

Deflection Factor Characteristics

range 2.00 mV/div to 10.0 V/div
 resolution 3 digits
 accuracy ±3%

Procedure Press **VOLTS DIV** (channel 1 or 2) and change deflection factor with the Control Knob. Use **FINE THRESH** to select step resolution.

To toggle between inverted and noninverted display, press **1 INV** or **2 INV**.



Program Codes

Enter channel 1 or 2 sensitivity:

VS <channel>,[<polarity>]<setting>

channel ::= 1 vertical channel 1
 2 vertical channel 2

polarity ::= + non-inverted display
 - inverted display

value ::= exponential
 {n.dd|nd.d|nnd}{e|E}[+|-|<SP>][d|d]
 2.00e-03 to 1.00e+01 V/div

Example Change channel 1 deflection factor to -100 mV/div.

<p>LOCAL (keys)</p>	
<p>REMOTE (codes)</p>	<p>VS1, -100e-3 <CR><LF> EOS</p> <p>identifier channel polarity value</p>

Vertical Deflection Factor (Cont'd)

Indication Deflection factor of enabled channels is displayed in the CRT readout.

When the Control Knob is assigned to channel deflection factor, the LED readout displays the parameter value and the corresponding key (channel 1 or 2 ) is lighted. Also, the channel name is displayed by the CRT readout in inverse video.

Comments When a recommended HP 10080 series miniprobe with division ratio readout is connected, channel deflection factor is entered and displayed as the total deflection factor at the probe tip.

Vertical deflection factor can only be changed if the channel is on or is a trigger source.

Related Sections Delta Volts
Trigger, Delayed Sweep
Trigger, Main Sweep
Vertical Mode
Vertical Position

Vertical Mode









Description In V vs T mode, the 1980A/B can display channel 1, channel 2, or both channels 1 and 2. Also, the algebraic sum of channels 1 and 2 can be displayed.

Multiple waveforms are displayed using alternate or chop display mode. In alternate, traces are displayed on alternate sweeps. Chop mode displays all traces during each sweep by switching between vertical (and horizontal) signal sources at a 400 kHz rate. The display is blanked during switching time. When automatic selection is enabled, multiple traces are displayed in alternate for sweep speeds slower than 1 msec/div and in chop for sweep speeds faster than 1 msec/div.

1+2 mode allows a composite waveform to be viewed. It provides a differential mode of operation when channel 1 or 2 is inverted.

Differential Mode Characteristics

bandwidth dc to 20 MHz
 CMR 20 dB with common mode signal
 amplitude equivalent to 10 div and one
 channel adjusted for optimum rejection

- Procedure** Press  to toggle channel 1 on or off.
- Press  to toggle channel 2 on or off.
- Press  to display the algebraic sum of channel 1 and 2. To return to normal channel display, press  or .
- To select alternate or chop vertical display mode, press  or  respectively.
- Press  for automatic alternate/chop selection.



Program Codes

Select vertical mode:

VM <mode>

- mode ::=
- 0 channels 1 and 2 off
 - 1 channel 1 only
 - 2 channel 2 only
 - 3 channel 1 + channel 2
 - 4 channels 1 and 2 on

Vertical Mode (Cont'd)

Select mode of display:

AC < mode >

- mode ::=
- 1 alternate sweep
 - 2 chop sweep
 - 3 automatic selection

Example Select chop sweep vertical display mode.

LOCAL (keys)	
REMOTE (codes)	

Display channel 1 + channel 2:

LOCAL (keys)	
REMOTE (codes)	

Indication Vertical mode and vertical display mode selections are indicated by lighting the corresponding keys. Also, the CRT readout displays the deflection factor of the enabled channels.

Comments If the 1980A/B is in dual horizontal mode, chop mode is not permitted for main or delayed sweep speeds greater than 1 $\mu\text{sec}/\text{div}$. The display mode will default to alternate mode (unlighted) when either sweep speed is faster than 1 $\mu\text{sec}/\text{div}$. If sweep speed is changed to 1 $\mu\text{sec}/\text{div}$ or slower, the original vertical display mode is restored.

Related Sections Horizontal Mode
Trigger View

Vertical Position

Description The vertical position of channel 1 or 2 is adjustable from the front-panel and via the HP-IB. Trace baseline can be positioned as much as 10 divisions off screen.

Vertical Position Characteristics

position range -15.00 to +15.00 div
 resolution 0.02 major division
 accuracy $\pm(2\%$ of reading + 0.3 major division)

Procedure To adjust the vertical position of channel 1 or 2, press  (channel 1 or 2), then adjust the Control Knob for desired setting.



Program Codes

Set channel 1 or 2 vertical position:

VP<channel>,<value>

channel ::= 1 channel 1
 2 channel 2

value ::= decimal
 [+|-|<SP>|] [d]d.d[d]
 -15.00 to +15.00 divisions
 value must be a multiple of 0.02 div

Example Change channel 1 position to +3.5 divisions.

<p>LOCAL (keys)</p>	
<p>REMOTE (codes)</p>	<p>VP1, +3.5 <CR> <LF> EOS</p> <p>identifier _____ channel _____ position value _____</p>

Vertical Position (Cont'd)

Indication When the Control Knob is assigned to vertical position,  is lighted and the LED readout displays the parameter value.

Comments The vertical position of a channel cannot be changed if the channel is off or only used as a trigger source.

If an odd integer (to the nearest hundredth) is entered via the HP-IB, it will be rounded to the nearest even value; positive values are rounded down, negative values are rounded up.

A probe key closure at channel 1 or 2 causes a momentary shift in the vertical position of that channel's trace for trace identification.

Related Sections Delta Volts
Vertical Mode

3-55. HP-IB CODES AND FORMAT SUMMARY



HP-IB Capability:

As described in IEEE Std 488, and ANSI Std MC1.1, the instrument's complete capability is: SH1, AH1, T5, TE0, L3, LE0, SR1, RL1, PPO, DCO, DT1, CO, E2.

HP-IB Status Advisory:

The following instrument states are indicated on the CRT in the HP-IB status advisory:

- R - Switched to remote mode
- L - Addressed to listen
- T - Addressed to talk
- S - Sent the Require Service message

Address:

Set or displayed by calling the HP-IB ADDRESS MODE menu.

The address is preset at the factory to 7 decimal; 00111 binary.

General Input Data Message Format:

```
<program code>[;<program code>]...[;][<CR>]<LF>
```

format rules: The 1980A/B sends and receives Data messages in standard ASCII code.

<LF> is used as the End-of-String (EOS) message for all input Data messages.

If several program codes are sent in a Data message, all but the last must be delimited by a semicolon (;).

Program codes consist of a two character identifier (prefix) and a parameter field containing zero, one or several parameters.

Unsigned parameters are interpreted as positive values.

In integer parameters, leading zeroes may be omitted.

Multiple parameters within a program code are delimited by a comma (,).

The character "E" or "e" is used to delimit the mantissa of exponential parameters.

Exponential parameters may be entered in scientific or engineering notation.

In Data messages, spaces (<SP>) are permitted only following program code identifiers and parameter delimiters.

The maximum Data message length is 127 characters including: <CR>, <LF>, <SP>, comma and semicolon.



The instrument cannot be unaddressed during input or output Data message transfers. If the instrument is unaddressed and then readdressed, the data transfer is aborted and a syntax error is reported.

All valid program codes for the Measurement System are listed in Table 3-26. Specific format requirements and parameter descriptions are included.

General Output Data Message Format:

<SP><setting value><CR><LF>

During Learn String outputs, the instrument sets the EO1 bus control line true with the last character of the string to indicate end of string. All other output Data messages use <LF> for the EOS message.

Table 3-26 includes specific descriptions of output Data message format. Refer to the functions "READING SETTINGS" and "INSTRUMENT STATUS" (program code identifiers "OF" and "OQ" respectively).

Return to Local:

Press  -if not in Local Lockout mode.

Default Conditions:

Several HP-IB parameters are reset at power-on and when the HP-IB ADDRESS MODE menu is selected. The instrument address and addressing mode, however, are preserved. The parameter default conditions are:

- * HP-IB local mode
- * Local-lockout cleared
- * Unaddressed
- * RQS mask cleared (mask=0)
- * SRQ message cleared
- * Status byte (register) cleared
- * HP-IB status advisory enabled

Status Byte:

When no conditions are enabled to cause SRQ (mask value=0), a single status byte is available that indicates which conditions have occurred since the byte was reset.

When one or more of the conditions are enabled to cause the SRQ message (mask value>0), as many as 9 separate occurrences can be queued in a status byte register stack. The stack is read on a first-in, first-out basis by serial polling the instrument until bit 7 (the RQS bit) goes false. If there are more than nine occurrences before the register stack is read, the stack will contain the codes for the first eight events and for the last condition that occurred.

The status byte (status byte register stack) is cleared when it is read, at power-on and when the HP-IB ADDRESS MODE menu is selected.

Table 3-24. The Status Byte and RQS Mask



Bit	8	7	6	5	4	3	2	1
Mask Weight	128	64	32	16	8	4	2	1
Service Request Condition	SRQ Key	RQS Bit	Plug-in Option Request	Internal Option Request	Advisory or Error	End of Sweep	Key Closure	HP-IB Syntax Error

Notes: 1. To set the RQS bit and SRQ bus control line true, the condition must be enabled in the RQS mask.

2. If no condition is enabled, the 1980A/B can not set the SRQ bus control line nor the RQS bit true. However, bits 1-6 and 8 of the status byte are set to indicate which conditions have occurred.

Table 3-25. Program Code Prefix to Function Cross Reference

Code Prefix	Function	Code Prefix	Function
AC	Vertical Mode (alt(chop))	KY	Key
AS	Autoscope	ML	Main Trigger (level)
AV	Advisory Messages	MM	Main Sweep Mode
BA	HP-IB Status Advisory	MS	Main Sweep Speed
BW	Bandwidth Limit	MT	Main Trigger (source, slope, coupling)
CG	Character Generator	OF	Reading Values (output function)
CI	Trace Intensity	OQ	Instrument Status (output qualifier)
CH	Text (with attributes)	RC	Control Knob
CL	Calibrator Level	SA	Autoscope (selective)
DD	Digital Delay	SG	Trigger Flag (single sweep)
DL	Delayed Trigger (level)	SK	Soft Key
DM	Delayed Sweep Mode	SM	Scope Mode
DS	Delayed Sweep Speed	SP	Dual Separation
DT	Delayed Trigger (slope, source, coupling)	SW	Trigger Flag (sweep wait time)
DV	Delta Volts	TE	Learn Mode (teach)
DY	Delay Time	TF	Trigger Flag
DZ	Delta Time	TV	Trigger View
FP	Character and Lamp Intensity	TX	Text
HM	Horizontal Mode	VC	Vertical Coupling
HP	Horizontal Position	VM	Vertical Mode (channel selection)
IM	SRQ Condition (input mask)	VP	Vertical Position
IN	Initialize	VS	Vertical Deflection Factor

Table 3-26. Program Codes and Format Summary

Function	Program Code	Function	Program Code
ADVISORY MESSAGES	AV <state>	HORIZONTAL MODE	HM <mode>
off	state ::= 0	main	mode ::= 1
on	1	intensified	2
AUTOSCOPE		delayed	3
Execute autoscope:	AS	dual	4
Execute selective autoscope:	SA	HP-IB STATUS ADVISORY	BA <state>
BANDWIDTH LIMIT	BW <state>	off	state ::= 0
off	state ::= 0	on	1
on	1	INITIALIZE	
CALIBRATOR LEVEL	CL <level>	Execute initialize:	IN
0.02 V p-p	level ::= 1	INSTRUMENT STATUS	
0.1 V p-p	2	Specify data to be read:	OQ <code>
0.2 V p-p	3	HP-IB syntax error code	code ::= 1
1 V p-p	4	last key code	2
10 V p-p	5	trigger flag state	3
CHARACTER GENERATOR	CG <state>	advisory or error code	4
readout on	state ::= 0	internal option code	5
readout off	1	plug-in option code	6
CONTROL KNOB	RC <entry> [, <mode>]		output format: <SP>ddd<CR><LF>
Assign control knob:		INTENSITY, READOUT	FP <char> [, <lamp>]
hold	entry ::= 0	CRT Readout intensity:	char ::= integer!
channel 1 deflection	1	(% full character brightness)	dd
channel 2 deflection	2		0 to 99%
main sweep speed	3	Lamp (and LED) intensity:	lamp ::= integer!
delayed sweep speed	4	(% full lamp brightness)	dd
channel 1 position	5		0 to 99%
channel 2 position	6	INTENSITY, TRACE	CI <value 1> [, <value 2>]
channel 1 position	7	Main intensity level:	value 1 ::= integer!
channel 2 position	8	(% max intensity)	dd
dual separation	9		0 to 99%
horizontal position	10	Delayed intensity level:	value 2 ::= integer!
main trigger level	11	(% max intensity)	dd
delayed trigger level	12		0 to 99%
delay	13	KEY	KY <code> [, <code>] ...
delay	14	Valid keycodes are listed in	code ::= integer!
delay	15	table 3-27.	dd
trace intensity	16	LEARN MODE	
character intensity	17	Specify Learn String output:	TE
panel intensity	18		output format: 80 eight bit bytes
Select step resolution:		Configure the 1980A/B using	EOS = EOI bus
coarse steps	mode ::= 0	the Learn String:	control line true
fine steps	1		<80 byte string><CR><LF>
DELAY		Note: The Learn String must be	transferred without sending
Enter delay time:	DY <value>		UNL or UNT.
(seconds)	value ::= exponential	READING VALUES	
	[+][d.d[.][E e]][+][-][d]d	Select function to be read:	OF <code>
	up to 9 digits	channel 1 deflection factor	code ::= 1
	+0.00e-09 to	channel 2 deflection factor	2
	+9.999 999 999 9e +00 sec	main sweep speed	3
	min step = 100 psec	delayed sweep speed	4
Enter digital delay:	DD <value>	channel 1 ΔV	5
(delayed trigger events)	value ::= integer!	channel 2 ΔV	6
	[d..]d	channel 1 position	7
	up to 7 digits	channel 2 position	8
	0 to 99 999 999 events	dual separation	9
DELTA TIME	DZ <state>	horizontal position	10
ΔT mode off	state ::= 0	main trigger level	11
ΔT mode on (and zeroed)	1	delayed trigger level	12
DELTA VOLTS	DV <channel>, <mode>	delay time	13
vertical channel 1	channel ::= 1	ΔT	14
vertical channel 2	2	digital delay	15
			F7
ΔV off	mode ::= 0		
ΔV on (and zeroed)	1		
HORIZONTAL POSITION	HP <value>		
(divisions)	value ::= decimal		
	[+][-][d]d.d[d]		
	-6.00 to +6.00 div		
	minimum step = .02 div		

NOTE: !In integer parameters, leading zeroes may be omitted.

Table 3-26. Program Codes and Format Summary (Cont'd)









Function	Program Code	Function	Program Code
READING VALUES (Cont'd)		SWEEP MODE, MAIN Triggered auto-start single sweep reset	MM<mode> mode ::= 1 2 3 4
	F# Output Format F1 -SP>[+]d,dddE[+]d<CR><LF> F2 -SP>d,dddE[+]d<CR><LF> F3 -SP>[+]d,ddd<CR><LF> F4 depends on trigger source	SWEEP SPEED, DELAYED (seconds/division)	DS<value> value ::= exponential {+}[n,dd,ind,d]ddd{E e}[+][d]d 5.00e-09 to 9.99e+00 sec/div
	line, internal: -SP>[+]d,ddd<CR><LF> external+1: -SP>[+]d,ddd<CR><LF> external+10: -SP>[+]d,ddd<CR><LF> external+100: -SP>[+]d,ddd<CR><LF>	SWEEP SPEED, MAIN (seconds/division)	MS<value> value ::= exponential {+}[n,dd,ind,d]ddd{E e}[+][d]d 5.00e-09 to 9.99e+00 sec/div
SCORE MODE V vs I 1 vs 2 external X, Y, Z	SM<mode> mode ::= 1 2 3	TEXT DISPLAY Erase all text Write character string TX<line, #>[<string>] line # ::= integer dd 1-14,16	
SEPARATION, DUAL (divisions)	SP<value> value ::= decimal {+}[d]d{d}d 5.00 to +5.00 div	The 1980A/B modified ASCII character set is listed in table 3-28. Write character string with special display attributes: CH<line#>[<string>] line # ::= same as for TX string ::= 7 to 28 bytes long, counting attribute bytes and characters String must contain four attributes Attributes must be separated by at least one character First byte must be an attribute	
SRO CONDITION Mask value is the sum of the weights of the conditions to be enabled.	IM<value> value ::= integer ddd	TRIGGER, DELAYED Enter delayed trigger level. The trigger level value is interpreted according to the current trigger source. internal trigger (divisions) external+1 (Volts) external+10 (Volts) external+100 (Volts)	MTI< slope>[< source>,< coupling> slope ::= + - source ::= 0 1 2 3 4 5 6 7 coupling ::= 0 1 2 3 4 5 6 7
SOFT KEY MENUS	SK<code>[<code>] code ::= 0 1 2 3 4 5 6 7 8	TRIGGER FLAG Set flag mode. delayed trigger, latched delayed trigger, dynamic main trigger, latched main trigger, dynamic	TF<mode> mode ::= 1 2 3 4
Condition HP-IB syntax error Key (except  ,  , ) End of sweep (after "SG") Advisory or error message Internal option request Plug-in option request	Weight 1 2 4 8 16 32 128		
OPTION MENU 			
PARAMETER MENU 			
CHAR. SELECT 			
SAVE 			
SAVE 			
RECALL 			

Table 3-26. Program Codes and Format Summary (Cont'd)

Function	Program Code	Function	Program Code
TRIGGER, DELAYED (Cont'd) Set delayed trigger conditions. triggers on positive slope triggers on negative slope previous source (no change) vertical channel 1 vertical channel 2 external+1 external+10	DTI< slope>[< source>,< coupling> slope ::= + - source ::= 0 1 2 3 4 coupling ::= 0 1 2 3 4 5 6 7	TRIGGER FLAG (Cont'd) Initialize flag, enable single sweep Set maximum sweep wait time. (expressed as total of three factors of delay) time in units of 23 μsec time in units of 5.84 msec time in units of 1.5 sec	SG SW<factor 1>,<factor 2>,<factor 3> factor 1 ::= integer ddd 0 to 999 factor 2 ::= integer ddd 0 to 999 factor 3 ::= integer ddd 0 to 999
TRIGGER, MAIN Enter main trigger level. The trigger level value is interpreted according to the current trigger source. line & internal trigger (divisions) external+1 (Volts) external+10 (Volts) external+100 (Volts)	MI<value> value ::= integer {+}[d]ddd dd -20.00 to +20.00 div d -1.200 to +1.200 V dd -12.00 to +12.00 V ddd -120.0 to +120.0 V	TRIGGER VIEW Trigger view off main trigger view delayed trigger view	TV<mode> mode ::= 0 1 2
SCORE MODE V vs I 1 vs 2 external X, Y, Z	SM<mode> mode ::= 1 2 3	VERTICAL COUPLING channel 1 channel 2 GND AC DC DC 50Ω	VC<channel>,<coupling> channel ::= 1 2 coupling ::= 0 1 2 3
SEPARATION, DUAL (divisions)	SP<value> value ::= decimal {+}[d]d{d}d 5.00 to +5.00 div	VERTICAL DEFLECTION channel 1 channel 2 non-inverted display inverted display deflection factor (Volts/division)	VS<channel>,<polarity>,<value> channel ::= 1 2 polarity ::= + - value ::= exponential {n,dd,ind,d]ddd{E e}[+][d]d 2.00e-03 to 1.00e+01 V/div
SRO CONDITION Mask value is the sum of the weights of the conditions to be enabled.	IM<value> value ::= integer ddd	VERTICAL MODE Select input channels. channels 1 and 2 off channel 1 only channel 2 only channel 1 + channel 2 channel 1 and channel 2 on Select alternate or chop alternate sweep chop sweep automatic selection	VM<mode> mode ::= 0 1 2 3 4
SOFT KEY MENUS	SK<code>[<code>] code ::= 0 1 2 3 4 5 6 7 8	VERTICAL POSITION channel 1 channel 2 position (divisions)	VP<channel>,<value> channel ::= 1 2 value ::= decimal {+}[d]d{d}d -15.00 to +15.00 div

Table 3-27. 1980A/B Keypcodes

Code	Key	Code	Key	Code	Key	Code	Key
0	MAIN (main)	18	TRIG DIV (dly'd)	36	AC (dly'd)	54	SRG (main)
1	MAIN (main)	19	TRIG DIV (ch 1)	37	AC (ch 1)	55	SRG (ch 1)
2	MAIN (main)	20	TRIG DIV (ch 2)	38	AC (ch 2)	56	SRG (ch 2)
3	MAIN (main)	21	TRIG DIV (ch 1)	39	AC (ch 1)	57	SRG (ch 1)
4	MAIN (main)	22	TRIG DIV (ch 2)	40	AC (ch 2)	58	SRG (ch 2)
5	MAIN (ch 1)	23	TRIG DIV (ch 1)	41	AC (ch 1)	59	SRG (ch 1)
6	MAIN (ch 1)	24	TRIG DIV (ch 2)	42	AC (ch 2)	60	SRG (ch 2)
7	MAIN (main)	25	TRIG DIV (main)	43	AC (main)	61	SRG (main)
8	MAIN (main)	26	TRIG DIV (dly'd)	44	AC (dly'd)	62	SRG (dly'd)
9	MAIN (main)	27	TRIG DIV (ch 1)	45	AC (ch 1)	63	SRG (ch 1)
10	MAIN (main)	28	TRIG DIV (ch 2)	46	AC (ch 2)	64	SRG (ch 2)
11	MAIN (main)	29	TRIG DIV (ch 1)	47	AC (ch 1)	65	SRG (ch 1)
12	MAIN (dly'd)	30	TRIG DIV (ch 2)	48	AC (ch 2)	66	SRG (ch 2)
13	MAIN (dly'd)	31	TRIG DIV (main)	49	AC (main)	67	SRG (main)
14	MAIN (dly'd)	32	TRIG DIV (dly'd)	50	AC (dly'd)	68	SRG (dly'd)
15	MAIN (ch 2)	33	TRIG DIV (ch 1)	51	AC (ch 1)	69	SRG (ch 1)
16	MAIN (ch 2)	34	TRIG DIV (ch 2)	52	AC (ch 2)		
17	MAIN (main)	35	TRIG DIV (main)	53	AC (main)		

*Code 64 means no key has been pressed since power-on.

Table 3-28. 1980A/B Text Character Set (Modified ASCII)

decimal	char	decimal	char	decimal	char	decimal	char
0	<SP>	32	<SP>	64	A	96	a
1	<LF>	33	!	65	B	97	b
2	<CR>	34	"	66	C	98	c
3	<TAB>	35	#	67	D	99	d
4	<HT>	36	\$	68	E	100	e
5	<VT>	37	%	69	F	101	f
6	<FF>	38	&	70	G	102	g
7		39	'	71	H	103	h
8	<ESC>	40	(72	I	104	i
9	<F1>	41)	73	J	105	j
10*	<F2>	42	*	74	K	106	k
11	<F3>	43	+	75	L	107	l
12	<F4>	44	,	76	M	108	m
13*	<F5>	45	-	77	N	109	n
14	<F6>	46	.	78	O	110	o
15	<F7>	47	/	79	P	111	p
16	<F8>	48	0	80	Q	112	q
17	<F9>	49	1	81	R	113	r
18	<F10>	50	2	82	S	114	s
19	<F11>	51	3	83	T	115	t
20	<F12>	52	4	84	U	116	u
21	<F13>	53	5	85	V	117	v
22	<F14>	54	6	86	W	118	w
23	<F15>	55	7	87	X	119	x
24	<F16>	56	8	88	Y	120	y
25	<F17>	57	9	89	Z	121	z
26	<F18>	58	:	90	[122	{
27	<F19>	59*	;	91	\	123	
28	<F20>	60	<	92]	124	~
29	<F21>	61	=	93	^	125	^
30	<F22>	62	>	94	_	126	_
31	<F23>	63	?	95	~	127	~

* <LF>, <CR>, and "<HT>" are not permitted within text strings.

Table 3-29. HP-IB Syntax Error Codes

HP-IB Code	Syntax Error Description
1	Parameter out of range
2	Command not recognized
3	Missing terminator
4	Unexpected character
5	Input buffer overflow
6	Data output not specified

3-56. NOTATION CONVENTIONS AND DEFINITIONS

The following conventions are used in this manual in descriptions of remote (HP-IB) operation:

< > Angular brackets enclose descriptive words that are used to symbolize a program code parameter or an HP-IB command.

::= "is defined as". For example, <A> ::= indicates that <A> can be replaced by in any statement containing <A>.

[] Square brackets indicate that the enclosed items are optional.

{ } When several items are enclosed by braces, one, and only one, of these elements must be selected.

| "or": Indicates a choice of exactly one element from a list. For example, <A> | indicates <A> or but not both.

... An ellipsis (trailing dots) is used to indicate that the preceding element may be repeated one or more times.

The following definitions are used:

d ::= A single ASCII numeric character, 0-9.

n ::= A single ASCII nonzero, numeric character, 1-9.

<LF> ::= ASCII linefeed (decimal 10).

<CR> ::= ASCII carriage return (decimal 13).

<SP> ::= ASCII space (decimal 32).

Table 3-30. Commonly Used Code Conversions

Table with 11 columns: HP-IB, ASCII, Decimal, Binary, Octal, Hexa-decimal, HP-IB, ASCII, Decimal, Binary, Octal, Hexa-decimal. Rows include Addressed Command Group (ACG), Universal Command Group (UCG), Listen Address Group (LAG), and Secondary Command Group (SCG).

NOTES: 1. L<n>#MLA assigned to device number <n>. 2. T<n> = MTA assigned to device number <n>. 3. Meaning defined by Primary Command Group code.

